

Specific Regulations for Cross Country Events (P)



(P) Cross Country Events

Organisers' Regulations: Applying to All Events

1.1. A Motorsport UK Organising Permit is required for any form of Cross Country event and is issued at the sole discretion of Motorsport UK.

1.1.2. The Motorsport UK Organising Permit number, and the Competition Authorisation Office (CAO) authorisation numbers where applicable, must be included in the Final Instructions.

1.1.3. A Club will only be allowed to run events up to Interclub status, unless Motorsport UK has specifically approved an application for National or International status.

1.1.4. Every practicable precaution must be taken to avoid depositing mud or soil on the public highway when leaving private property.

1.1.5. Warning notices as required by D.31.1 to D.32.5 must be displayed.

1.1.6. Organisers should be aware of the nearest hospital and the best route there in case of incident.

1.1.7. The organisers of events on a single site must have on site at a pre-identified locations a First Aid Kit in compliance with requirements for 11-20 employees as specified in BS 8859-1:2011 (and including an eye bath).

1.1.8. No person under 14 may act as a Marshal or Assistant Marshal unless under the direct supervision of a Marshal over 18 years old.

1.1.9. Competition Licences should be signed by the Clerk of the Course, if the holders complete the event without any adverse report. Signatures may be obtained by both Driver and Navigator.

1.1.10. The use of the public forest estates managed by Natural Resources Wales, Forestry and Land Scotland, and Forestry England, must have been approved by Motorsport UK. Permission must be applied for by an annually specified date, prior to the Forestry year (which runs 1 January - 31 December). All Cross Country Events are restricted to the tyres defined as All Terrain in 56.7.4.

1.1.11. The Clerk of the Course for either a Competitive Safari or a Hill Rally of National status or above must hold a valid Motorsport UK CoC Licence. For details of retention and upgrading see Section G.22.

Official Recovery

1.2.1. With the exception of Challenge Events, Team and Winch Recovery events, all recovery operations will be under the control of the Clerk of the Course.

1.2.2. All equipment to be used by the Official Recovery Teams must be inspected prior to the start of an event, and the Clerk of the Course must be satisfied that it is in good condition and adequate for the purpose intended.

1.2.3. *All Official Recovery Teams should be sited by the Clerk of the Course, and the method used in recovering stranded Competitors must be specified in the Supplementary Regulations (SRs).

1.2.4. It is recommended that all vehicles used for Official recovery should have any front or rear windows, whether glazed or not, covered with a metal mesh, expanded metal or gauze. This is particularly important where 'snatch' recovery is to be employed.

Fire Extinguishers

1.3.1. At each section organisers should provide fire extinguishant of a minimum 9kg total capacity, in units of not less than 6kg each, suitable for extinguishing vehicle fires.

1.3.2. This extinguisher can be carried by a Section Marshal escorting Competitors around the various sections.

1.3.3. Where sections are closely grouped, one extinguisher located at a clearly visible central point is permitted.

Footpaths, Bridleways and Restricted Byways

1.4. The Organisers of any Cross Country event (competitive or recreational) crossing or using a Footpath, Bridleway or Restricted Byway, whether competitively or not, must appoint a Liaison Officer to verify the status of any track or path along the route, ensure compliance with Section 33 of The Road Traffic Act 1988 and:

1.4.1. Obtain permission from the Landowner and any occupiers and authorisation from the Highway Authority in accordance with Section 33 of The Road Traffic Act 1988 (unless the route is already a way of higher status). Any conditions laid down must be adhered to.

1.4.2. Notify the Police (clarifying the nature of the event).

1.4.3. Notify the National Parks (if appropriate) 1.4.4. Notify the Parish Council.

1.5. In particular, all locations must be adequately marshalled by Officials who are well briefed and properly identified.

1.5.1. One Official must be appointed for each section to ensure that the event does not unduly inconvenience other users, eg horse-riders, walkers, cyclists etc.

1.5.2. The Official must have a good working knowledge of the Rights of Way affecting the Competition.

1.5.3. Alternative routes for other users of the Rights of Way must be signposted. Warning Notices (D.31.1.2, D.31.1.3, D.31.1.5) as appropriate and the Safety Code should also be on display in all areas.

1.5.4. Instructions to Competitors in SRs and Final Instructions for events affecting Footpaths or Bridleways should include the following warning: This event is routed along and/or across Rights of Way. Competitors must exercise caution and reduce their speed accordingly near other users. Be especially careful near horses. Slow down, stop and switch off your engine if necessary.

Note: Throughout these sections an asterisk(*) indicates a requirement for additional information to be printed in the Supplementary Regulations (SRs). Text shown in Italics indicate a Regulation which may be amended in the SRs. Text shown in red indicates a new or amended regulation for 2020.

Judges

1.6. Judges may be appointed to adjudicate on any infringements of the Regulations including:

- 1.6.1.** Touching markers.
- 1.6.2.** Conforming with the course.
- 1.6.3.** Remaining seated in accordance with the Regulations.
- 1.6.4.** Stopping forward motion.
- 1.6.5.** Noise.
- 1.6.6.** Baulking.
- 1.6.7.** Entitlement to a re-run.

Spill Kits

- 1.7.1.** At each section, Organisers must provide at least one medium spill kit.
- 1.7.2.** This spill kit can be carried by a Section Marshal escorting Competitors around the various sections.
- 1.7.3.** Where sections are closely grouped, one spill kit located at a clearly visible central point is permitted.
- 1.7.4.** For all Hill Rallies, Competitive Safaris, Point to Point, Challenge Events and Orienteering a medium spill kit must be located at the start of the course, each Special Stage or section.

Organisers' Regulations: All Events Using the Highway

2.1. The SRs must specify the time at which Competitors must report at the Start, and whether or not public roads are used to link sections of the Competition.

2.2. Any Competition traversing a highway in England, Wales or Scotland is subject to the provisions of the Motor Vehicles (Competitions and Trials) Regulations. In particular:

- 2.2.1.** Application for authorisation of an event must be made to the Competition Authorisation Office (CAO) at Motorsport UK, or for Scotland to the Royal Scottish Automobile Club. Details of the Authorisation Procedures are available from Motorsport UK and RSAC as appropriate.
- 2.2.2.** Deleted.
- 2.2.3.** Application for a Motorsport UK Permit must be made in accordance with D.41 prior to the CAO Authorisation being granted. The Permit itself is only validated after authorisation has been granted.
- 2.2.4.** In the case of road courses, route selection is subject to Motorsport UK approval. Applications must include a detailed itinerary giving the exact distances to be covered.

2.2.5. Vehicles should be checked for sound by qualified Driving Standards Observers before the start and along the route, and noisy cars stopped if necessary.

2.2.6. Any Holding Controls should be located to avoid public nuisance. Sensitive areas along the route should be drawn to Competitors' attention. Marshals should be well briefed and readily identified.

2.3. Instructions on sensible use of the roads should be issued, including the following:

- 2.3.1.** Closing of gates, etc.
- 2.3.2.** Clearing of roads at section ends.
- 2.3.3.** Following the 'Country Code', failure of which can lead to disciplinary action.

Duties and Responsibilities of the Clerk of the Course

2.4. In addition to the duties detailed in G.5, the Clerk of the Course should ensure:

- 2.4.1.** The Organisation and Regulations for the event meet the requirements of the relevant Statutory Instruments.
- 2.4.2.** Reasonable precautions are taken in the selection of route, time of day, control of spectators, etc, to avoid inconvenience to the general public.
- 2.4.3.** Where the farming community may be affected, details of the event are sent to the County Secretary of the local National Farmers' Union and any other relevant National bodies.
- 2.4.4.** The appointed CAO Route Liaison Officer for each of the Counties and National Parks through which the route passes is consulted about the draft route at least three months before the event and before submission to the CAO, particularly where special public relations work is required in sensitive areas.

The Route Liaison Officer may:

- (a) Ask to see all paperwork relating to the event, including PR sheets
- (b) Request the CAO to suspend authorisation, or Motorsport UK to suspend the Permit, until satisfied with the route and the effectiveness of the PR work
- (c) Require the Clerk of the Course to order re-routes to avoid areas of particular concern.

2.4.5. Exercise discretionary judgement on where competitive sections may be run and their length, and withhold agreement to the route if not satisfied with any aspect of the organisational standards or route planning.

2.4.6. Private property, whether on the event route or a link section, is not to be used without written permission from the landowner or authorised agent.

2.4.7. Wherever possible the route should be checked for possible damage immediately before and after an event.

2.4.8. When the Motorsport UK medical and safety radio frequency (81.575Mhz FM and 81.5375Mhz FM) is to be used, it must be operated in accordance with Ofcom and Motorsport UK licensing requirements (available on request) (14.2).

Time Schedule

2.5.1. Wherever Competitors are on a public highway, they must be controlled by a predetermined speed schedule, unless they are allowed to complete the event in their own time.

2.5.2. The event time schedule must not lead Drivers to exceed any statutory speed limits, or involve speeds which might be considered dangerous or unreasonable in the light of prevailing traffic conditions and the nature of the route.

2.5.3. No time or speed schedule should be imposed which requires or encourages Competitors using a road open to the public to achieve an average speed between any two points which exceeds the following limits:

- (a) 30 mph for all roads other than motorways
- (b) 60 mph for motorways
- (c) 25 mph for vehicles subject to a speed limit (such as vans)
- (d) 20 mph for neutral sections (3.4, 3.5) (except on M, A or B class roads).

2.5.4. In addition there must be no bonus for exceeding the specified average. Competitors must be given in advance all the information necessary to enable them to calculate the speed which they are being asked to average 26.1.11.

2.5.5. For those portions of the route being navigated by map references, the direction of approach to controls should be specified and penalties imposed for approaching from any other direction whenever the country being traversed makes this possible without destroying the need for competitive skill.

2.5.6. The use of gated roads should be avoided if possible.

2.5.7. If Competitors are to traverse a gated road, adequate arrangements must be made to ensure that all gateways are manned by Marshals to ensure that no Competitor is required to open a gate, and that all gates are closed after the Competition.

2.5.8. Occupiers of land adjacent to the road must be advised in advance of the Competition.

2.5.9. The use of single track roads should be avoided if possible during daylight, but if used, the speed set must be lowered as appropriate.

2.5.10. Those sections of an event involving difficult navigation by map references or a detailed route card must be scheduled so that no Competitor is traversing minor roads during the morning or evening hours when normal farm traffic may be expected, unless the required average speed is not more than 20mph.

2.5.11. No Competitor is allowed to drive more than 200 miles continuously without a break, and there must be a rest period of at least one hour for each Driver at intervals of not more than 200 miles (25.2.5).

2.5.12. Any event which runs for more than 14 hours must include a rest halt of at least two hours, unless previously agreed with Motorsport UK.

Controls

2.6.1. Controls must be sited at locations with adequate space for Officials' and Competitors' cars to stop without affecting non-rally traffic.

2.6.2. Controls must be sited at least 500m from occupied houses, except where written approval has been obtained from the occupants.

2.6.3. All controls must be clearly identified at the roadside (26.1, 35).

2.6.4. Controls at which Competitors are required to stop to record a time, and which are on the public highway, must not be less than two miles from any adjacent control.

2.6.5. Competitors must be provided with all necessary regulatory information at or before their starting time.

2.6.6. Competitors must be started on the road sections of an event at intervals of one minute and leave the start in numerical order, unless the SRs specify a longer time interval or a different order.

Official Documents

2.7. In addition to D.10, the SRs must clearly state:

2.7.1. The type of event (Hill Rally, Trial etc) that is being organised, and whether or not there will be standard sections, special stages, regularity sections, trials sections or other types of test.

2.7.2. When details of the route or any section or stage will be issued.

2.7.3. Any maps (and their scale) required and any modification of 51.4. In any dispute concerning mileages, these shall be calculated in accordance with 1:50,000 OS maps (or equivalent local maps).

2.7.4. The type of timing to be used.

2.7.5. A reminder of which sub-sections of the Technical Regulations apply.

2.7.6. Whether or not vehicles are required to be taxed and insured for use on the highway (60.1).

2.7.7. Whether Competitors are required to carry Competition numbers (25.1.5, 36.4, 41.2, 50.5.1).

2.7.8. Whether servicing is Permitted and if so the manner in which service vehicles will be identified.

2.7.9. If competing cars or Service Vehicles are required to carry any identification markings, the name of the organising Club must be incorporated on the identification.

2.7.10. Any information which is required in order to comply with 26.1, 27.4.2.

2.8.1. All Official bulletins, Permits and authorisations, times and results (unless issued in accordance with D.26.1.2) must be published on an Official Notice Board whose location must be notified to Competitors (G.3.2, G.11.2.2, 24.1.1).

2.8.2. Stewards (or Observers for the upgrading of an event) should be supplied with a complete marked map of the route prior to the date of the event, and a set of all instructions and route cards, etc that are issued to Competitors and Officials as soon as they are available.

2.9. The Road Book, Route Card or Time Card shall clearly:

2.9.1. Indicate the description of each section (Standard, Neutral, Transport, Regularity, Trial etc) (3.1).

2.9.2. Specify the time allowed to traverse the route between each Time Control and all the information necessary to enable Competitors to comply with 2.4.

2.9.3. Indicate what information the Organisers require to be recorded and the places at which these records will be made (26.1.8, 35), except as provided for in 27.2.

2.9.4. Indicate which checks will be manned by Officials, except checks established in accordance with 27.2.

2.9.5. Specify which portions of the route shall be timed to less than one minute.

2.9.6. Indicate any 'out of bounds' areas to be respected.

2.9.7. Indicate the position of all Stop signs along the route, any other junctions at which Competitors are required to stop, and any areas where they are required to observe special restrictions (ie Quiet Zones, etc).

2.9.8. Specify the order in which controls and checks must be visited.

Sound Testing

2.10. Prior to the start all cars, including those of Officials who are expected to follow a substantial part of the route, must pass a sound test conducted by an Environmental Scrutineer using a sound meter, as prescribed by the Technical Regulations (J.5.17, G.10.1 to 11.2).

2.10.1. This test will prohibit any vehicle with a reading over 100dB(A) from starting, unless the SRs specify lower levels.

2.10.2. All measurements refer to the 0.5m test (1.5.17).

2.10.3. Organisers must make arrangements for a suitable site to be available for testing and ensure that adequate personnel are appointed.

2.10.4. A further sound test for Competitors and Course Cars must be made on the road sections. These must be manned by a Driving Standards Observer (G.11.1 to 11.2, 27.2), experienced Judges (G.10.1, 27.1) or by Judges using a sound meter. They have the authority to penalise Competitors on the spot and their findings must be recorded in the results of the event whether or not any Competitor has been disqualified.

2.10.5. The sound test Official may also act as a Driving Standards Observer.

Eligibility Checks

2.11. At events involving different Classes of vehicle, arrangements to undertake eligibility checks should be available prior to the Competition, or on conclusion.

2.11.1. All vehicles, including Course Cars, must comply with the relevant Technical and Safety Regulations.

2.11.2. Checks may be carried out both before and during an event.

2.12. The Chief Scrutineer must be available throughout the event to ensure that the Technical Regulations are complied with.

Timekeeping

2.13. A Motorsport UK-approved Rally Timekeeper should be appointed as a Chief Timekeeper for any event where timing is to less than one minute.

2.13.1. The Chief Timekeeper appointed for the event is responsible for the issuing of timing equipment and ensuring that the Timekeepers who will be using the equipment are competent in its use.

2.13.2. The Chief Timekeeper must be able to deal with operational problems affecting timing equipment and be capable of dealing with queries arising from the time cards.

2.13.3. Any section of an event which has timing to less than one minute must be timed by certified equipment, digital clocks to Motorsport UK specification R or E/B, recording clocks printing to seconds, or automatic apparatus.

2.13.4. All Official clocks or watches must be set to GMT/BST time.

2.13.5. Any Official timepiece timing to the minute which is not within 15 seconds of GMT/BST, or any Official timepiece timing to the second which is not within five seconds of GMT/BST, will be disregarded.

2.13.6. Times will be recorded to whole minutes, unless the SRs state otherwise.

2.13.7. Any portions of an event to be timed to seconds will be clearly indicated in the Road Book, Route or Time Card.

Definitions of Event Sections

3.1. The following definitions and restrictions apply to the various sections of an event.

Standard Sections

3.2. If timed to the second, Standard Sections should not:

3.2.1. Pass through any area with over 20 occupied dwellings within a 300m radius of the route, unless with written agreement from all the householders and Motorsport UK permission.

3.2.2. Start before 23.59 or finish more than one hour after sunrise.

3.2.3. Include any point where Competitors are required to observe special restrictions on their driving behaviour, except for observing signs warning of natural hazards (which may be erected by Organisers). 'Quiet' zones or other restrictions are specifically forbidden.

3.2.4. Join or cross any A-class road, except where there is a manned control at which Competitors must stop.

3.2.5. Start on or use an A-class road continuously for more than 200m.

3.3.1. When timed to less than one minute, Competitors must not use any private property, other than footpaths and bridleways for which approval has been granted.

3.3.2. Additionally Organisers must not:

- (a) Offer any award for Competitors who equal or improve upon the time schedules for individual sections, nor have any awards for the fastest times or least penalties on any sections
- (b) Operate a Flying Finish time control
- (c) Include any road with a 30 or 40mph limit without the express permission of the RLO
- (d) Require Competitors to average in excess of 30mph.

Neutral Sections

3.4. Neutral Sections are used to take Competitors through PR-sensitive or densely populated areas and must comply with 3.3.2.

3.4.1. They should be completed by Competitors without the use of auxiliary lighting, except legally required in fog or falling snow.

3.4.2. Organisers must remind Competitors of this requirement in their SRs.

3.5. Neutral Sections should not:

3.5.1. Be timed to less than one minute.

3.5.2. Allow Competitors to make up time on the public road.

3.5.3. Have any lateness penalty applied, except maximum lateness.

3.5.4. Have an average speed of more than 20mph, except on M, A or B class roads.

Regularity Sections

3.6. Competitors must be informed in advance of the locations of the Start and Finish of any Regularity Sections.

3.6.1. Each Section must contain at least one Intermediate Time Control, the location of which must not be given to Competitors in advance.

3.6.2. Competitors must, however, be advised in writing before entering such a section whether they are required to stop at Intermediate Time Controls which must be identified by a Control Board.

3.6.3. Adherence to the time schedule in a Regularity Section is assessed by comparing the time of arrival at any Intermediate Time Control (or the Finish Time Control) with the time of arrival at the preceding Time Control. Timing, whether or not the car is required to stop, is based on the moment a car enters the Time Control area.

3.6.4. Penalties, which must be specified in the SRs, are imposed for stopping within sight of but outside the area of any Intermediate Time Control (or the Finish Time Control).

Transport Sections

3.7. Transport Sections are used to move Competitors between other types of section where the route is not PR sensitive or densely populated.

3.7.1. Transport Sections must also comply with 3.3.2 and 3.3.4.

3.7.2. If using roads with 30mph or 40mph limits in force, Organisers must impose a lower average speed commensurate with the proportion of restricted roads in the section.

3.8. Transport Sections must not:

3.8.1. Be timed to less than one minute.

3.8.2. Be less than four miles in length.

3.8.3. Have any lateness penalty applied, other than for maximum lateness.

Road Sections

3.9. Road Sections comprise any sections of a route on a Hill Rally (excluding control and service areas), whether on the public highway or not, which link Special Stages.

3.9.1. When on the public highway, these sections must comply with 3.1 to 3.8.3 (except 3.2, 3.3.1 and 3.3.2(a)).

Trials Sections (47-58)

3.10. A Trials Section is a test laid out over undulating ground designed to bring Competitors to an involuntary stop.

3.10.1. The course comprises a series of 'gates' defined by marker canes where Competitors' performance is measured according to the number of gates 'cleared' without stopping, leaving the course or touching a course marker.

Special Stages

3.11. Special Stages are timed sections run on roads or land for which the event has exclusive vehicle access, or on public roads Officially closed for motor sporting purposes.

3.11.1. If run partly or wholly on unsealed surfaces, they should be organised so that no Competitor achieves an average speed in excess of that specified in 11.3.2.

3.11.2. Special Stages should be over a distance of not less than a half mile.

3.11.3. No stage exceeding 20 miles may be run without written permission from Motorsport UK.

3.12. Special Stages should not:

3.12.1. Include any checks or controls or other requirements which might require or encourage Competitors to stop.

3.12.2. Use any sections of a venue in opposite directions at the same time, unless there is at least a 15m separation between the two routes with a continuous barrier. Cross-roads used twice must preserve this separation. The barrier must consist of one or more of the following: tyres banded in threes, straw bales, earthbanks or similar immovable objects. Motorway cones or blocking tape are not suitable.

3.12.3. Use any currently, or previously, licensed Race, Speed or Kart circuit, or any airfield (disused or otherwise) unless Motorsport UK has specifically approved the stage layouts and safety precautions.

3.12.4. Be routed closer than 75 metres to any parked aircraft, unless there is a solid physical barrier at the edge of the course protecting the aircraft and a gap of 45 metres from the barrier to the aircraft.

Public Relations

4.1. Effective public relations work must be undertaken by Organisers of all events using the Highway. The following advice will be useful:

4.1.1. Prior consultation with Route Liaison Officers who might require additional PR work in sensitive areas is essential. The work should be completed to allow enough time to undertake a re-route should this prove necessary.

4.1.2. Be diplomatic, positive and clear about the legal aspects of route authorisation. If the event is run in England or Wales, do not intimate that it is authorised by the Police.

4.1.3. Avoid asking for 'authorisation' or 'permission' from householders as this can invite unnecessary difficulties. Special consideration should be given to householders with pets or livestock.

4.1.4. All PR must be carried out by responsible members of the organising Club or of a Local Club. All PR letters should be vetted and checked by the RLO and must indicate who the Organiser is (with a contact address and phone number), the date of the event, in which direction it is travelling, and the approximate time of passing.

4.1.5. Where Organisers publish a guide to the route, or specific locations for spectators, they should ensure that:

- (a) Householders within 500m of any specifically advised location have been effectively contacted without difficulty and that these areas are properly Marshalled
- (b) The information contains warnings of locations that spectators should avoid (blackspots, sensitive areas etc).

4.1.6. Ensure that each PR crew prepares a report on each visit and that these are available to the RLO on request, and to the Clerk of the Course and Stewards at the event. Special note should be made of problem areas and reports must be passed to RLOs for the benefit of future events.

4.1.7. Contact should be made with local Police stations before and immediately after all events.

4.2. See charts 10(a) and 10(b) Section R, Appendix 1 for detailed requirements.

Events Using the Highway (except Hill Rallies)

4.3. All Events Using the Highway (except Hill Rallies) must comply with the following:

4.3.1. The location of all 'Give Way' junctions on the route must be issued to Competitors along with clear instructions as how to deal with them (36.2).

4.3.2. Organisers must familiarise themselves with the medical and ambulance facilities along the route.

4.4. Treasure Hunts must comply with the following:

4.4.1. No merit must attach to being the first to arrive at the Finish or any other point.

4.4.2. Competitors must not be required to arrive at any point other than the Finish at or by a specific time.

4.4.3. Where an overall time limit is set for an event, it must be possible to win without exceeding an average speed of 10mph from Start to Finish.

4.4.4. Competitors must not be required to travel more than 100 miles on a highway or to perform any task or solve any problem that is likely to inconvenience or offend other road users or the general public.

Organiser's Regulations: Trials and Un-timed Events

Cross Country Vehicle Trials (41.1 to 43.4)

5.1. These trials must be organised in accordance with 1 to 4 as appropriate, and the use of road sections should be avoided.

5.1.1. The SRs must clearly state if the highway is to be used (2.1 to 2.3).

5.2.1. Where applicable, Competitors should be split into equal groups, which should start at different observed sections simultaneously.

5.2.2. The Start and Finish of observed sections must be marked by signs and the Starts should be reasonably flat and wide so that all Competitors can at least enter the section.

5.2.3. The layout of sections should take account of the location of possible failure points and, particularly for Tyro Trials, safe exit routes.

5.2.4. The layout should facilitate Marshalling by the minimum possible number of Officials.

5.2.5. Sections should be as wide as possible to allow a choice of route and as winding as possible to place a premium on driving skill (although the radius of all corners must be adequate for all vehicles entered).

5.2.6. Course markers should not be placed against trees.

5.2.7. The use of trees or natural hazards as course boundaries should be avoided.

5.2.8. If possible, alternative routes should be planned in case of changes of weather condition.

5.3. It is recommended that sections be laid out using a minimum of 10 pairs of marker stakes (see Appendix 1, drawing number 5.3) of a minimum height of 1m, and with colour coding to clearly identify each side of the route.

5.3.1. Metal rod markers should not be used.

5.3.2. Markers should be placed to avoid the likelihood of Competitors putting all wheels out between markers, or where they are likely to be moved by bushes or branches.

5.4. Clearly visible sub-section numbers should have a minimum figure height of 50mm.

5.4.1. If sub-section numbers are not placed on both sides of the route, they should be on the right-hand side with corresponding guide markers on the left.

5.4.2. Sub-section numbers should be closely grouped in areas of expected failure.

5.5. A minor proportion of the sections can be timed, but any time penalties must be related using a published formula to points lost on a section.

5.5.1. Timed sections must be a maximum of 200m long, and the maximum time allowed for the section shall be stated.

5.5.2. Approaches to and exits from sections must not present any unreasonable hazard or difficulty.

5.6. There should be sufficient Marshals at each observed section to ensure safety procedures are followed, and adequate Judges in attendance (1.6).

5.7. Organisers may at any convenient time after the start of a Competition require any Competitor to increase or decrease their minimum Permitted tyre pressure by a maximum of 5lbs/sq.in. This decision must be advised to Competitors in writing and sufficient time allowed for them to comply.

Junior Trials (45)

6.1. Junior Trials must be organised in accordance with 5, and at all times during these event vehicles may only be driven under the instruction of an Official.

6.1.1. Where a Junior Trial is held concurrently with another event at the same venue, the area for the Junior Trial must be adequately separated and clearly defined.

6.1.2. Special consideration must be given to the terrain chosen, particularly with regard to side slopes and drops, and water should generally be avoided.

6.1.3. Where present, the maximum depth of any water must be 0.2m.

6.2. There are three Classes of Junior Trial: Novice, Intermediate and Expert.

6.2.1. The maximum Permitted gradients for each is as follows:

Novice Intermediate Expert

The maximum 50% 60% N/A longitudinal gradient

The maximum 25% 35% N/A transverse gradient.

6.2.2. A Motorsport UK Observer may be appointed at Junior Trial events.

Tyro Trials (44)

7.1. These must be organised in accordance with 5, and the following:

7.1.1. The terrain chosen should ensure that vehicles do not catch any bodywork on approach, ramp breakover, or departure angles, and consideration should be given to the vehicles entered when laying out sections.

7.1.2. Any longitudinal gradient must be 50% maximum.

7.1.3. Any transverse gradient must be 25% maximum.

7.1.4. The depth of any water must be 0.3m maximum.

7.1.5. Vehicles must be capable of traversing sections without making contact with any trees, bushes or other natural features.

7.1.6. No features may be included within sections which are likely to cause damage to the underside of competing vehicles.

Winch Recovery (46)

8.1. The aim of these events is to safely and precisely winch an object between two points via gates and different routes as defined in the written instructions. They must be organised in accordance with 1 to 1.6 and the following:

8.1.1. The Course can be laid out over any type of terrain but must be on private ground in an area prohibited to spectators. It must be taped or roped off to indicate the boundary to Competitors and spectators and comply with 8.1.4.

8.1.2. Natural anchorages may be used at the discretion of the Clerk of the Course but must be protected from damage.

8.1.3. All objects to be recovered must have a good quality chain attached, to the satisfaction of the Clerk of the Course. If the object is a vehicle then all glass must be removed where appropriate. The steered wheels may be locked in any position and one or more wheels may be removed.

8.1.4. The Clerk of the Course may stop a team if their mode of recovery is considered likely to be dangerous to officials, competitors, spectators or the natural terrain. Penalty points will be awarded if any gate or previously specified object is touched by either the object or team.

8.1.5. The Organisers will allocate Competition numbers at random and teams will start in numerical order.

Promotional Events (47)

9.1. These are non-competitive events designed to enable participants to experience driving their vehicles off-road and to introduce them to organised off-roading. They must be run in accordance with D.5.1 and the following:

9.1.1. They must consist primarily of a liaison route or routes wholly off the public highway, which may also include optional, simple, and non-damaging, trials type sections.

9.1.2. The liaison routes and any special sections should be clearly marked and adequately Marshalled.

9.1.3. Clubs may not organise more than three Promotional Events per year.

Organiser's Regulations: Timed Events

Cross Country Vehicle Timed Trials (48)

10.1. These trials must be organised in accordance with 5. and the following:

10.1.1. The instructions must state the maximum time and the target time allowed to complete each section.

10.1.2. The target time must be set at no more than 22mph (10m/s) average.

10.1.3. The maximum length of any Timed Trial section must not exceed 320m.

10.1.4. Events must be timed using equipment as specified in 11.4.

10.1.5. Each section must be clearly identified and must be a prohibited area for all persons except Officials and those Competitors attempting the section (D.31.1.2).

Competitive Safaris (49)

11.1. Competitive Safaris must be organised in accordance with 1 and the following:

11.1.1. All courses must be on private ground and should be laid out at one venue only.

11.1.2. Timed sections must run over roads or tracks from which all vehicle and animal traffic has been excluded. These need not be marked on definitive maps.

11.1.3. The route should be made as safe as possible and unmistakable for Competitors and spectators.

11.1.4. Means of access, both to the section and to the site, should be closed by barriers and signs to prevent any non-competing vehicle gaining access.

11.1.5. Warning notices as detailed in D.31.1 to 32.5. should be displayed, and areas of particular danger (eg escape routes) should be marked with signs as specified in D.31.1 to 32.5.

11.2. It should be impossible for anyone on foot to get on to any stage through normal access roads or tracks without:

11.2.1. Being aware of it.

11.2.2. Having been seen by an Official.

11.2.3. Having seen a warning notice.

11.2.4. Having seen the Safety Code.

11.3. The course can involve trials type sections, the surmounting of natural obstacles or hazards, or points at which the crew may be required to dismount to perform a set task.

11.3.1. Wherever possible the course should be not less than one mile long, and where the terrain makes this impossible, at least a quarter mile long.

Timing

11.3.2. The average speed must not exceed 30mph unless run in accordance with minimum safety requirements of a Hill Rally Special Stage, when the average speed must not exceed 50mph. Competitive Safaris timed in excess of 30mph shall be referred to as Safari Plus.

11.3.3. No Competitor exceeding the specified average speed should gain any advantage nor be penalised.

11.3.4. Competitors must not be offered any award for equalling or improving on the target time, or achieving the fastest times or least penalties for such sections.

11.4. For Clubmans events the following is strongly recommended. Interclub and higher events must be timed by:

11.4.1. Certified equipment.

11.4.2. Digital clocks to Motorsport UK Specification R or E/B.

11.4.3. Recording clocks printing to seconds, or

11.4.4. Automatic apparatus.

11.5. All times recorded must be to the previous whole second only.

11.5.1. Where timing is actuated by a light beam, vehicles must be positioned at the Start with the part which will break the beam 1 to 2 metres behind the beam.

11.6. Where an event is timed manually, and the Start Marshal has instructed a Competitor that they are next to start, the starting procedure shall be either of the following:

11.6.1. The Marshal will give a loud verbal indication of 30 seconds to go, 15 seconds, 10 seconds and 5 seconds, and then count down verbally each second 5-4-3-2-1-GO. Upon the signal GO, a visual starting signal must be given, which will normally be the raising of a flag from the bonnet (not the windscreen). Any other visual signal to be used must be described in the event SRs. False starts will be penalised in accordance with charts 30.1.1(h) or 30.1.2(h).

OR

11.6.2. Before the illumination of the green light indicating that a Competitor may start, a red light is illuminated warning that their countdown is imminent. The SRs must specify the countdown method. Timing will start from the green light, whether or not the Competitor starts immediately on its illumination.

11.7. Courses and Stages where Competitors are required to start at intervals of less than one minute may dispense with the '30 seconds to go' advance warning. This procedure must be advised in the SRs.

Course Organisation

11.8. There must be adequate communication between Start, Finish and intermediate points.

11.8.1. Adequate Marshals must be posted along the course, particularly at any potentially dangerous points, at any observed section and where recovery operations may be required.

11.8.2. Rescue vehicles must be positioned at Predetermined locations, to transport any injured crew or Officials to the medical or first aid facilities.

11.8.3. Motorised reconnaissance of the course is forbidden, unless specifically allowed by the SRs, and then only if run to the requirements of a Promotional Event, and in a controlled convoy with lead and tail Official course vehicles.

Course Marking

11.9. The course should have a clearly marked route so that no navigation is required, and all course markings should comply with 51.1.

11.9.1. The correct route should be indicated to Competitors by arrows and signs, and by physical blockage of all but the correct road.

11.10. These indications must, wherever possible, be consistent with the illustrations overleaf and with the following:

11.10.1. Arrowing should be reduced to a minimum and placed only at junctions.

11.10.2. Really acute bends or hazards where a drastic reduction in speed is required should be marked by a Caution Board. Caution Boards, comprising red exclamation Marks on a white background 51cm x 38cm, will be displayed on each side of the stage between 40 to 50 metres before the hazard. At the hazard a pair of diamond shaped orange markers at least 150mm x 150mm will be placed each side of the stage. These will be repeated, in pairs, on each hazard if there is more than one hazard to which the warning refers (see Appendix 1, chart 11.10).

11.10.3. All signs should be placed approximately 1.2m from the ground. Wherever possible arrows and signs should be Dayglo red or orange and should be easily visible. To avoid confusion, multiple signs on one post should be avoided.

11.10.4. Advance warning signs for junctions should be between 50m and 100m before the junction. Two arrows should be visible on the junction, fixed so as to form a 'gate' through which the Competitor will pass. Arrows may be angled to show the severity of the junction, indicated by one of four basic positions, either vertical, horizontal, raised or lowered by 45°.

An example of the method used must be shown to Competitors before the event.

11.10.5. A vertical arrow should confirm the correct route immediately after a junction.

11.10.6. A wrong direction should be indicated by a standard No Entry sign (a red disc with a white bar) and all but the correct road should be visibly blocked by means of tree trunks.

11.11.1. The location of all Motorsport UK-listed danger spots on the route must be clearly marked in the Road Book or Stage Tulip Diagrams.

11.11.2. Special warning signs, a minimum of 51cm x 38cm and fixed on a stake, must be erected in a clearly visible position.

11.11.3. The sign must show two exclamation marks, and be preceded at 50m and 100m by similar exclamation marks.

11.11.4. Both signs must be Marshalled throughout the event.

11.11.5. Other hazards should be indicated by single exclamation signs 50m and 100m before the hazard (a Motorsport UK list available to Organisers on request).

11.12.1. If a section of road is used twice on stages where the route divides, or where two roads merge, the junction itself should be clearly marked by a white board at least 76cm x 61cm, illustrating the nature of the junction.

11.12.2. Figures on this board should be at least 16cm high.

11.12.3. The junction should be preceded by similar signs at 100m and 200m showing Motorway-type count down diagonal bands.

11.12.4. Judges of Fact should be placed at the split junction to record penalties on Competitors overshooting and reversing back against the route of competitive traffic.

11.12.5. Where Competition routes merge on a lapping course, the angle between the two roads (prior to the common route) should be no more than 45° to each other, and on joining should run separately, but in parallel, for at least 100m before merging.

11.12.6. Signs of a minimum size of 76cm x 51cm must be shown to Competitors as detailed in Appendix 1, chart 26(b).

11.13.1. Arrows must have a bright, preferably Dayglo finish facing the Competitor.

11.13.2. Where the course changes direction repeatedly without any natural features, arrows must have a contrasting colour on the reverse side (preferably matt black or white) with tape staked at reasonable intervals to further define the course.

11.14. The Flying Finish line must be located a sufficient distance from the Stop Line to allow Competitors to decelerate in a controlled manner, especially where they proceed directly into a Service Area.

11.14.1. Bad weather, slippery conditions and the speed potential of cars crossing the Flying Finish Line will require a greater distance.

11.14.2. The area between the Flying Finish and the Stop Line should be free from bends, sharp or deceptive corners or hazards such as gates or ditches. This area is prohibited to spectators.

Senior Officials

12.1. The Clerk of the Course at a National or International Competitive Safari must be licensed as in 1.1.11.

12.2. The Chief Scrutineer at a Competitive Safari must be appointed from the list of Motorsport UK Technical Officials.

12.3. An Event Safety Officer should be appointed, experienced in the operation of current competitive safaris, who appreciates the potential problems of vehicles competing in differing conditions. The same Officer may also assume the duties of Chief Marshal and can be responsible for ensuring effective arrangements are in place to supplement the general Marshalling strength organised by the Clerk of the Course as follows:

12.3.1. There should be pre-determined arrangements available for summoning appropriate emergency services, via rendezvous points if necessary, to the scene of an incident.

12.3.2. Unless the complete route is visible from the Start or Finish areas, there should be an effective radio communications network (excluding CB radios) operated through a nominated Controller under the direction of the Clerk of the Course, linking Officials at the Start, Finish and intermediate points with rescue and medical services.

12.4. The Chief Medical Officer or Chief Paramedic, being a Doctor or Motorsport UK Registered Paramedic, is responsible – in consultation with the Clerk of the Course and the Event Safety Officer – for ensuring that the required level of medical and rescue cover is provided.

Live Recovery

13.1. At Competitive Safaris and Hill Rallies, Live Recovery (the recovery of stranded Competitors whilst the course or stage is still live) may only be undertaken in accordance with the following:

13.1.1. The SRs must state whether Live Recovery will be operating at an event and the Clerk of the Course must brief Drivers on the procedures.

13.1.2. It can only be undertaken by dedicated Specialist Recovery Vehicles (SRVs) deployed by the Clerk of the Course at potentially difficult locations.

13.1.3. It must not be used for accidents which must be dealt with by the appropriate medical and rescue services deployed by the Clerk of the Course.

13.1.4. The SRV must comply with 58.1 and be equipped with appropriate tyres, substantial towing points, a suitable tow rope, a Yellow Flag, a roof mounted amber warning beacon and a radio (either on the Motorsport UK medical and safety frequency (2.4.8) or on a PMR frequency licensed for the event: CB Radio is not acceptable).

13.1.5. The crew will comprise a minimum of two people who must wear high visibility jackets at all times. The first will operate the SRV and radio communications, the second will warn other Competitors that Live Recovery is in progress by displaying a Yellow Flag at a suitable distance ahead of the recovery location.

13.1.6. It is the Competitor's responsibility to attach and detach the tow rope from the SRV vehicle during Live Recovery. Exceptionally, where available, a third crew member can attach and detach the tow rope and supervise the operation. Three-person crews are strongly recommended for National events.

13.1.7. Procedures must be identical for each SRV deployed at an event.

13.2. The procedure for a Live Recovery operation must be as follows:

13.2.1. The SRV must report the number of the stranded vehicle by radio and should not commence operations without permission.

• The second crew member then proceeds on foot to a safe distance ahead of the stranded vehicle and displays a Yellow Flag to warn other Competitors that a Live Recovery is taking place.

13.2.2. The SRV must display a flashing amber beacon and flashing hazard lights at all times during Live Recovery.

13.2.3. In reaching a stranded vehicle, it must avoid travelling across or along the course, except in positioning itself to approach the recovery from a down-course direction, and place the stranded vehicle between it and approaching Competitors.

13.2.4. Course Marshals may assist the SRV crew and must ensure all spectators are kept clear.

13.2.5. Wherever practicable, the stranded Competitor must be pulled through or over any obstruction in the direction of travel along the course.

13.2.6. When the SRV is in position, the first crew member should instruct either the Passenger or Navigator of the stranded vehicle (or the third crew member) to attach the tow rope between the vehicles. Once attached, they must stand clear and indicate to the first crew member that it is safe to commence recovery.

13.2.7. On completion of the recovery, the first crew member will indicate to the Passenger or Navigator (or third crew member) that it is safe to detach the tow rope between the vehicles, ensure that the tow rope is properly stowed and then indicate to the first crew member that it is safe to move the SRV clear.

13.2.8. Once the first crew member reports that the SRV is clear, the second crew member can allow Competitors to proceed past the recovery location.

Hill Rallies (50-51)

14.1. These must be organised in accordance with 1 to 4, 10 to 13 and the following:

14.1.1. Competitors must be seeded in order of anticipated performance, with the first Competitor having the best performance potential, unless Motorsport UK has given prior approval to the contrary.

14.1.2. All special stages must not be less than a quarter mile long in demanding terrain, or 1 mile in other instances.

14.1.3. Trials-type sections or tests may be incorporated within special stages.

Duties and Responsibilities of the Clerk of the Course

14.2. In addition to the responsibilities detailed in 18, the Clerk of the Course should ensure the following:

14.2.1. The use of the public forest estates managed by Natural Resources Wales, Forestry and Land Scotland, and Forestry England has been approved by Motorsport UK. Permission must be applied for by an annually specified date, (1.1.10). No contact should be made with the Forestry Commission prior to receiving approval from Motorsport UK, or an appointed Forestry Liaison Officer.

14.2.2. Other motor sport users of venues to be included in special stages must be notified of arrangements.

14.2.3. The Chief Scrutineer must be appointed from the list of Motorsport UK Technical Officials.

14.2.4. A Stage Commander should be appointed for every stage, with the responsibility for ensuring that the stage complies with the Regulations.

14.3. An Event Safety Officer should be appointed. The Officer should be experienced in the operation of current Hill Rally stages and have an appreciation of the performance of Hill Rally vehicles in differing weather conditions.

14.3.1. The Officer should be assisted by a Spectator Safety Officer who is responsible for specific arrangements to accommodate spectators in suitable areas, to prevent their accessing unsuitable areas and to make suitable access facilities for spectators' use.

14.3.2. The Event Safety Officer is responsible for ensuring effective arrangements to supplement the general Marshalling strength organised by the Stage Commander as follows:

- (a) Ensure arrangements are available to every Stage Commander for summoning appropriate emergency services, via rendezvous points if necessary, to the scene of any incident
- (b) Unless the complete route is visible from the Start or Finish areas, provide an effective radio network, operated through a nominated Controller under the direction of the Stage Commander, linking Officials at Start Finish and intermediate points with rescue and medical services. The frequency must be secure and either the Motorsport UK Safety Frequency or a privately-licensed frequency to Ofcom Regulations.
- (c) The Controller must be experienced in the use of radios and in controlling a network, and must ensure the disciplined use of the radios. Where the Motorsport UK Safety Frequency is used, the Radio Controller must hold a valid Motorsport UK Controller's Licence (Notes on radio procedure are available from Motorsport UK).

14.4. Written instructions on the operation of the stages must be made available to all Officials and Marshals. These must clearly establish:

14.4.1. That the number of cars to be sent through any stage prior to the Competition is to be kept to a minimum; that the crew of each Course car has specific duties allocated by the Clerk of the Course on which they must report to the Stage Commander (or Deputy) immediately on completing each special stage; and that no stage can start until the Zero car crew have confirmed that the stage is ready for Competitors and Marshals have any spectators on the stage under their control (16.6).

14.4.2. That there must be no movement of any vehicle or of the rescue services once the stage has opened without the specific approval of the Stage Commander, and then only after suspending the stage and being satisfied that it is cleared of competing cars.

14.5. On special stages where it may be necessary to authorise the movement of non-competing vehicles prior to the stage being cleared, a system of red flags must be in place.

14.5.1. These flags can only be located at radio points and only displayed on the specific instruction of the Clerk of the Course or the Stage Commander.

14.5.2. Red flags must only be used when there is a Possibility of non-competing vehicles and rescue Services moving on a stage ahead of competing cars.

14.5.3. There must always be a red flag displayed at the Point where rescue or emergency vehicles join the route of a stage.

14.5.4. Competitors must be advised, in writing, which stages are operating this system and the procedure which they must adopt (51.1).

- (a) That under no circumstances will any car be allowed to drive in the reverse direction of the stage
- (b) That detailed emergency procedures and equipment have been made available by the Event Safety Officer
- (c) That the priorities in dealing with an incident are first to deal first with the injured by removing them in a suitable vehicle if it is safe to do so, and then to deal with the vehicles if they constitute a hazard to the continued running of the stage or to property
- (d) That no Competitor will be Permitted a re-run of a special stage (51.2.3)
- (e) That the system of ensuring Competitors are positively monitored and checked through a stage is explained. Organisers may either use numbered stage time cards or note the previous Competitor's Competition number with the next Competitor to leave the start
- (f) That all non-competing vehicles are parked in a safe place, or at least 30m from a road or track used as a Special Stage, between a point in advance of the Start control and a point 100m beyond the Finish stop control. Non-competing cars required solely for purposes of safety may be parked at any place designated by the Stage Commander as suitable
- (g) That any road or track which can form an escape road between the start and stop controls should be kept clear and unobstructed for a distance of at least 100m, bearing in mind the potential approaching speed of a Competitor
- (h) That the location of any competing car that fails to complete the stage is reported to the Stage Commander
- (i) That the information required by the Clerk of the Course to consider 14.6.4 is available if the stage is interrupted or stopped for any period of time
- (j) That reasonable precautions are taken to protect private property located adjacent to any stage against damage.

14.6. If the normal running of a Special Stage is stopped for any reasons after the passage of one or more Competitors, and it proves impossible to allow other Competitors to cover the stage competitively, the Clerk of the Course can give each crew that hasn't covered the stage a notional time corresponding to the slowest time set up before the interruption.

14.6.1. If the slowest time represents a complete anomaly, the next slowest time should be retained (and so on until the 5th slowest time).

14.6.2. However no crew which is totally or partially responsible for stopping a stage can benefit from this measure.

14.6.3. If they finish the stage, they will be given the time which they actually set, even if this is greater than the time awarded to other crews (27.4.3).

14.6.4. In any event seeding Competitors in reverse order of anticipated performance, the Clerk of the Course can give to Competitors a notional time corresponding to the fastest time set at the moment of any interruption, or apply the next fastest time (up to the 5th fastest time) if the fastest time represents a complete anomaly.

14.7. The Clerk of the Course has the right to:

14.7.1. Impose a penalty in accordance with 30.1.2(w) or 30.1.1(v) on any Competitor who causes or is part of a serious blockage on a Special Stage, whether intentionally or otherwise, if their actions prevent any other Competitor from completing the stage competitively.

14.7.2. Impose further penalties under C.2 as appropriate.

14.7.3. Appoint Officials to search Competitors and their vehicle for unauthorised Pace Notes (51.4). There should be two such Officials, one male to check male Competitors and one female to check female Competitors.

Special Stages

15.1. The route of a special stage may not be defined by grid references or any other method requiring Competitors to choose their own route.

15.1.1. Every effort should be made to site the Flying Finish at a point where cars can be expected to be travelling slowly as a result of a preceding bend or hazard.

15.1.2. No practising or testing is Permitted on any special stage before any event, unless specifically authorised by Motorsport UK.

15.1.3. The Flying Finish line must be at least 200m before the stop line, which should be at least 100m before any public highway.

15.1.4. Bad weather, slippery conditions and the speed potential of cars crossing the Flying Finish line will require these distances to be extended.

15.1.5. The area between the Flying Finish and the stop line should be free from bends, sharp or deceptive corners, or hazards such as gates, etc.

15.1.6. This area must be prohibited to spectators.

15.2. All Officials should be clearly identifiable and wherever possible:

15.2.1. Be in visual contact throughout the length of the stage.

15.2.2. Be in sight of all signs and arrows, and at prohibited areas.

15.2.3. Be placed where the public are expected to arrive to watch the stage.

15.2.4. Have some pre-arranged system for warning spectators of the approach of cars.

15.2.5. Be under the control of a Sector Marshal if appropriate.

15.3. Where a special stage forms a continuous circuit, Competitors must not be required to complete more than two laps.

15.3.1. Organisers should allow at least 100m separation from the start of the stage before Competitors join other cars already on the stage.

15.3.2. No individual stage on a multi-venue hill rally may use any particular section of road or track more than four times.

15.4. Throughout the event Stage Timing will be to the preceding second, using equipment as specified in 69.

15.4.1. The timing of any section should be recorded so that Competitors can ascertain its correctness. This prohibits the 'setting back' of the section finish watch.

15.4.2. Timing must be from a Standing Start to the Flying Finish line.

15.5. No Competitor should be allowed to gain an advantage by exceeding the specified average speed.

15.5.1. The time based on this average is referred to as the stage Bogey Time.

15.5.2. No award can be made to Drivers who improve upon or equal the Bogey Time, or for the fastest time or least penalties on such a stage.

15.6. Competitors must not be started from any stage start at intervals of less than one minute, unless in accordance with the following procedures:

15.6.1. Starts of between 30 second and one minute interval are Permitted, provided no undue difficulties are foreseen and:

15.6.2. The stage has no split route and does not exceed a total length of four miles if on an unsealed or mixed surface, or eight miles if completely on a sealed surface.

15.6.3. The stage is neither a currently nor previously licensed Race, Speed or Kart venue, or an airfield (disused or otherwise) 15.6.4. No part of any stage traverses the same section of route during the running of that stage, or as part of another stage running concurrently. If the stage constitutes a continuous circuit, it must be less than one lap.

15.6.5. Competitors have been seeded by the Organisers by performance in accordance with 14.1.1 without dispensation.

15.6.6. That suitable timing arrangements have been made at the Finish line.

15.7. Authorisation for stages not covered in 15.6 above must be obtained in writing from Motorsport UK and will only be considered when the following information has been submitted:

15.7.1. The individual stage name, number and location.

15.7.2. The length of the stage and the type of surface (forest, tarmac, etc).

15.7.3. The average width of the road or track.

15.7.4. Diagram(s) of venues showing stage routes and safety provisions.

15.7.5. The number of times Competitors are attempting the stage.

15.7.6. If Competitors are attempting the stage more than once, the time interval between a Competitor's first and second run, and the possibility of catching previous Competitors.

15.7.7. Whether Competitors attempting their second run will be interposed with Competitors still attempting their first run.

15.7.8. Whether the stage has a split route, and if so how far this is into the stage. On unsealed surfaces the stage must not consist of more than 2/2 miles of common route.

15.7.9. Whether extreme weather conditions will adversely affect a fair Competition.

15.7.10. Confirmation that suitable timing arrangements have been made at the Finish Line.

16.1. Any access to any part of a stage, whether from a car park or through entrances, should be protected by warning notices as specified in D.31.1.1, D.31.1.5, and is subject to the requirements of D.32.1.

16.1.1. A copy of the Safety Code should be displayed at all entrances where the public are likely to enter, and in areas considered to be hazardous (including escape routes and prohibited areas).

16.2. On stages or events where it is intended to charge for admission, whether directly or by programme sales, specific Motorsport UK approval must be obtained prior to any publicity material being circulated (16.3).

16.2.1. Motorsport UK will not authorise any admission charge for spectators unless adequate safety precautions for them, appropriate to speed events, are in place.

16.2.2. Where the nature of a venue means it is impractical to apply such precautions, or access by the public cannot reasonably be controlled, then only a car park charge may be made for which no Motorsport UK approval is required.

16.3. For events with a published programme, or where information is published which gives details of the location of special stages, a copy of the Safety Code should be included for the guidance of spectators.

16.3.1. The organisation of special stages should seek to ensure the route is made as safe as possible, and unmistakable to Competitors and spectators alike.

16.3.2. Means of access onto the stage should be closed by sufficient barriers and signs to prevent any non-competing vehicle gaining access.

16.4. It should also be impossible for anyone on foot to get on to any stage through normal access roads or tracks without:

16.4.1. Being aware of it.

16.4.2. Having been seen by an Official.

16.4.3. Having seen a warning notice.

16.4.4. Having seen the Safety Code.

16.5. Fire extinguishers of a minimum 9kg total capacity, in units of not less than 6kg each, (20lb/9kg dry powder type) must be available in any area defined as 'Service Area' or 'Paddock' and any area in which competing cars are assembled awaiting their attempt at the stage(s), and at stage finishes.

Course Cars

16.6. The only category of Course Car that may be driven through a stage at near competitive speeds will be a Zero car, identified by carrying markings of 0, 00, or 000 as appropriate.

16.6.1. No other Official car can carry such markings.

16.6.2. Zero cars must be the last vehicles to traverse a stage before the first Competitor, unless the Clerk of the Course authorises otherwise.

16.6.3. Zero Cars must only stop on the course in the case of emergency and must be fitted with an effective method of communicating with the start control Officials.

16.6.4. With the exception of Class eligibility, Zero Cars must pass the same pre-event scrutiny as Competitors.

16.6.5. There must be only be two crew member in each car, and they must wear helmets and seat belts, and have fire extinguishers fitted, as is mandatory for Competitors.

16.6.6. Both crew members must be signed-on Officials. It is recommended that the Driver is a Competition Licence holder and that one of them has been involved in pre-event planning.

16.6.7. No Driver who is barred from holding a Competition Licence may drive an Official, Course or Zero car over a competitive safari course.

Special Stages: Arrows and Signs (11.9) (51.1)

17.1. The course for those parts of Hill Rally Special Stages which are run on defined tracks must be defined in accordance with 11.9. Where the route does not follow defined tracks, the special stage shall be marked as follows:

17.1.1. Pairs of arrows must be erected to form a gate; sufficient stakes should be used to ensure each arrow remains standing and indicating the correct direction.

17.1.2. The arrows must point in the direction that the stage continues after the gate.

17.1.3. Consecutive gates must be approximately 100 metres apart, or in sight of each other, allowing for the lower seating position of crews in non-production vehicles. They should be approximately 6 metres wide, but in soft ground where a choice of route may be given, they can be approximately 20 metres wide.

17.1.4. A single warning arrow must be positioned approximately 25 metres ahead of numbered locations (rather than intermediate gates) and changes of direction of over 45° indicating the direction to be followed at the location.

17.1.5. If there is any doubt about route direction, tape should be used to form a funnel in the correct direction, or to define the outside of a corner.

17.1.6. Where the course repeatedly changes direction without any natural features, tape staked at reasonable intervals should be used to define the course.

17.2. All roads and tracks used must appear on the Competitors' maps, or any tulip diagram supplied.

17.2.1. These should show junction or hazard numbers or letters, indicate the intermediate mileages between junctions, any danger spots and hazards, and the direction to be taken.

17.2.2. This diagram must be approved by Motorsport UK prior to the event.

17.3. Location numbers must be placed on the single warning arrow as required by 17.1.

17.3.1. Each digit must be black and measure 76.3mm high and 12.7mm thick.

17.3.2. They must be in a sans serif font on a white background a minimum of 147mm tall x 104mm wide (ie if there are two digits the background will be 208mm wide).

Multi-Use Hill Rallies

18.1. *The SRs for Multi-Use Hill Rallies must state whether the Public Highway is being used or not.

18.1.1. No stage route may be used more than twice.

18.1.2. For a stage route to be recognised as different, it must vary by at least 20% if run in the same direction, or for it to be reversed.

18.1.3. No part of a stage may be used in any one direction more than 12 times during any event.

18.2. Venues where spectators are encouraged to attend should have a resident Spectator Control Car equipped with a PA system and a radio on the frequency to be used at the event.

18.2.1. A co-driver who has signed-on must be carried in each competing car and no practising is allowed.

18.2.2. Fire extinguishers must be available in any area defined as a service area or paddock, and any area in which competing cars are assembled waiting their attempt at a stage.

18.2.3. Motorsport UK may appoint a Steward for any event, and will do so where an event is confined to one venue.

18.2.4. Written Motorsport UK permission must be obtained in advance in respect of any other activity being held at the time of the event at the venue, in order to ensure whether suitable insurance can be arranged.

18.2.5. PR work, in accordance with 4.1, must be undertaken irrespective of whether or not the public highway is used on the event.

18.2.6. The Clerk of the Course at a National or International Hill Rally must be licensed as in 1.1.11.

Service Areas

18.3. All Service Areas should be under the supervision of a Safety Officer with suitable means of contacting the Emergency Services.

18.3.1. Special care must be taken to ensure that the areas are kept secure from spectators and that all aspects of Health and Safety Regulations are observed.

18.3.2. Adequate fire extinguishers must be available at the site.

Emergency Vehicles

18.4. The equipment and licensing criteria for Rally emergency vehicles are listed in Section F.

18.4.1. These vehicles comprise Rally Recovery Units, Rally Rescue Units and Stage Safety Units (SSUs).

18.4.2. To maintain safety cover, unless licensed vehicles are available, SSUs should be able to provide rescue, first aid and fire fighting to incidents within 15 minutes (ie starting from the beginning of a stage and proceeding in the direction of the stage).

18.4.3. It is recommended that an SSU is stationed at each stage start.

Medical and Safety Cover

Multi-Use Hill Rallies

19.1. At each venue there must be:

19.1.1. A Doctor or Motorsport UK-registered paramedic.

19.1.2. An Motorsport UK-licensed Rally (or Dual) Rescue Unit.

19.1.3. A Recovery Unit.

19.2. The Chief Medical Officer or Chief Paramedic, being a Doctor or Motorsport UK Registered Paramedic, is responsible – in consultation with the Clerk of the Course and the Event Safety Officer – for ensuring that the required level of medical and rescue cover is provided.

19.2.1. Their responsibilities should include the detailed organisation of doctors, their planning and deployment within stages, the organisation of ambulance meeting points and the notification of hospitals in relation to the stages.

19.2.2. The Chief Medical Officer or Chief Paramedic, and Safety Officer, in liaison with Stage Commanders, should be aware of the evacuation routes from all stages and rendezvous points.

19.2.3. Following consultation with the Clerk of the Course, the Chief Medical Officer or Chief Paramedic, may appoint a suitable deputy to take over the Chief Medical Officer's or Chief Paramedic's, duties in an emergency.

Hill Rallies Other Than Multi-Use

19.3. For Clubman, Interclub and National Multi-Venue Hill Rallies, there must be at every stage (or group of stages of which a maximum three are Permitted in close proximity):

19.3.1. A doctor or Motorsport UK-registered paramedic.

19.3.2. An Motorsport UK-licensed Rally (or Dual) Rescue Unit.

19.3.3. In addition, those stages without the a Motorsport UK Rescue Unit may position an Motorsport UK-licensed SSU at the start.

19.4. For every stage in excess of nine miles in length, in addition to the above, there must be at a suitable mid-point:

19.4.1. A doctor or Motorsport UK-registered paramedic.

19.4.2. A Motorsport UK-licensed Rally (or Dual) Rescue Unit or a Motorsport UK-licensed SSU.

19.5. It is recommended that an Motorsport UK-licensed Recovery Unit, or a commercially operated Recovery Unit, is placed at or near those stage start locations where a Rescue Unit is positioned.

19.6. For International Hill Rallies (other than FIA Championships) there must be at every stage start:

19.6.1. A doctor or Motorsport UK-registered paramedic.

19.6.2. A Motorsport UK-licensed Rally (or Dual) Rescue Unit.

19.6.3. A Recovery Unit.

19.6.4. For stages in excess of nine miles in length, these requirements must be repeated at a suitable mid-point.

International and National Hill Rallies

19.7. It is recommended that the Chief Medical Officer is appointed from the Motorsport UK Register and approved for the grade of rally being run.

19.7.1. A senior Medical Officer should also be appointed for each stage and be positioned at the stage start to work under the instructions of the Stage Commander.

19.8. Doctors should carry sufficient equipment as they feel necessary for the performance of their duties. The following is suggested:

- Airways x2
- Cervical collar
- Two large field dressings
- Powerful hand torch
- Space blanket
- First aid kit.

19.9. It is recommended that Organisers have available a full resuscitation kit.

19.10. All accidents and incidents involving injury must be reported in writing by both the Medical Officer and Stage Commander to the Clerk of the Course. A completed Motorsport UK report form, signed by the Doctor should be sent to the Medical Consultant at Motorsport UK.

Cross Country Orienteering (54)

20.1. These events must be organised in accordance with 1-1.6 and the following:

20.1.1. There should be no merit attached to being the first to arrive at any point, nor should it be necessary to arrive at any point other than the Finish by a specified time.

20.1.2. If an overall speed limit is set for an event, it must be possible to win without exceeding an average speed of 10mph from Start to Finish. Participants must not be required to travel more than 50 miles, nor to perform any task or solve any problem that is likely to offend anybody not taking part in the event.

20.1.3. When running an Orienteering event at night careful consideration should be given to restricting auxiliary lights. R18.5 is strongly recommended.

Team Recovery (52)

21.1. Any Team Recovery event must be organised in accordance with 1-1.6 and the following:

21.1.1. The event must be on private ground. The use of the Public Highway, including Rights of Way, is forbidden.

21.1.2. Only vehicles within the same team may be on any observed section at the same time.

21.1.3. At each observed section, Official Recovery Teams must be on duty in the location specified by the Clerk of the Course.

21.1.4. Rescue vehicles must be positioned at predetermined locations to evacuate any injured party.

Point to Point (53)

22.1. Point to Point events must be organised in accordance with 1-1.6 and the following:

22.1.1. They must be on private property at one venue only. They can incorporate open ground, tracks or roads, and can include arduous or demanding areas, water courses and other natural obstacles or hazards,

22.1.2. The ground should be an open area and positive steps (including the closure of tracks) should be taken to prevent vehicles meeting at blind points,

22.1.3. Only vehicles from the same team may be in any point at the same time,

22.1.4. The event must be timed in accordance with the requirements of 11.4.

22.1.5. Rescue vehicles must be positioned at predetermined locations to evacuate any injured party.

22.1.6. Adequate Marshals must be positioned at each point to be visited, and at locations overlooking the areas that Competitors will cross.

Challenge Events (55)

23.1. Challenge Events must be organised in accordance with 1-4 and the following:

23.1.1. The aim of the event is to drive, tow and or winch a vehicle(s) to the various identified points within the competition site, the location of which will be indicated in the SRs.

23.1.2. At each location will be a means to prove that the vehicle has reached the location, this will be identified by a number to verify it is the desired objective and will be attached to a fixed point by a cable. A score card (or other device) (attached by the scrutineer in a consistent point on all vehicles) must be marked as proof that the location has been visited. The vehicle must negotiate close enough to mark the scorecard without detaching either component.

23.1.3. The SRs will specify whether the event is for single vehicles or teams of vehicles.

23.1.4. The SRs will specify whether there is a class structure and specify the eligibility requirements for classes.

23.1.5. The SRs will specify the start time, finish time and any penalty which will be applied for late finishing.

23.1.6. The SRs will specify any start order and the method arrived at for employing it.

23.1.7. The SRs will specify the values of each point visited or any formula which is used to calculate the value of each point visited.

23.1.8. In addition there may also be Special Tasks at certain locations which are worth extra points. These may take the form of driving, mental or physical tasks, these may involve the use of the competing vehicle or alternatively a vehicle may be provided for the task. Each task will be overseen by a marshal who will issue instructions and record the score.

23.1.9. The SRs will specify the number of Special Tasks available on the day and their maximum scoring potential.

23.1.10. Special Tasks may be timed to an accuracy of one second.

23.1.11. Where a winch cable or rope may be deployed the area of that section shall be no less than the length of the outstretched winch cable of rope and only competitors attempting the section and the observing official may be present in the Section. Where SRs require all competitors to use synthetic winch rope the width of this area may be reduced.

23.1.12. Winch cable and rope must be presented in a serviceable condition.

Cross Country Driving Tests (55.2)

23.2.1. These events must be organised in accordance with 7 and the following:

Driving Test Layouts

23.2.2. Cars must not be allowed to travel more than 25m (between manoeuvres) without having to stop astride a penalty line, reverse or drive clear of the line or manoeuvre in a garage or box.

23.2.3. Competitors must either stop astride a penalty line or make a change of direction of at least 90° at a distance of not more than 20m before the Finish line.

23.2.4. The route must be made available to all Drivers before any test.

23.2.5. The start and finish of all tests must be in a forward direction.

23.2.6. All tests must be arranged so that the whole of the course is visible to the Driver from the Start Line unless competitors are given the opportunity to walk the course beforehand.

23.2.7. There must be no optional direction of travel, except as specified in 55.3.8.

23.2.8. Clarification of where and how a change of direction may be made without incurring a penalty must be available on request to all Competitors before the start of any test.

23.2.9. Spin turns are not permitted.

23.2.10. Practising for tests is not permitted.

23.2.11. Markers should be not less than 1m in height, unless the Supplementary Regulations (SRs) or test instructions specify otherwise.

23.2.12. Lines and gates must have a minimum width of 3.5m.

23.2.13. Any 'garage' must have a minimum length of 6m and a minimum width of 3.5m.

23.2.14. When Competitors are required to perform a 180° turn in a box, the size of the box must be sufficient to contain a circle of 16m diameter.

23.2.15. Each test should be designed so that a Competitor is not expected to engage reverse gear more than four times (ignoring manoeuvres to correct mistakes).

23.2.16. Each test must be run at least twice.

23.2.17. Each Competitor's worst performance at each test will be discarded in arriving at total penalties for the event.

Competitors' Regulations: All Events

24.1. Any Competition Licence holder who Permits the unauthorised presence at any time of any vehicle on a known or former Cross Country Course, a Special Stage or on private property including land owned or managed by the Defence Infrastructure Organisation, Natural Resources Wales, Forestry and Land Scotland, the Forestry England or DAERA Forest Service NI will be disqualified from any related event and referred to the MSC National Court.

24.1.1. No verbal instruction to Competitors regarding routes, time schedules, layouts or performance in a stage or test or section issued during an event will be valid.

24.1.2. Any instruction relating to these matters must be displayed as an Official notice at least 30 minutes before the first car is due to start a Competition, or issued in writing to each Competitor who must acknowledge receipt by signing an appropriate form (D.11.1.1, G.11.2.2, 26).

24.1.3. At the start, each Competitor, Passenger and vehicle will be checked for eligibility.

24.1.4. Any Competitor not reporting as instructed may be fined, disqualified or may forfeit their starting position.

24.2. Drivers and passengers must produce a valid Club Membership Card and Competition Licence as detailed in Section H.

24.2.1. For any Cross Country event where Crash Helmets are required and irrespective of licence grade, drivers, navigators and passengers who have any notifiable condition included within H10.1.9. may not apply for their competition licence on the day and should allow a calendar month for their application to be assessed and processed.

24.3. Drivers at Hill Rallies, Competitive Safaris, Team Recovery, Point to Point, Challenge Events and all events crossing a public highway must hold a current valid RTA licence appropriate to the vehicle.

24.3.1. Drivers at Trials, Winch Recovery, Gymkhanas, Treasure Hunts and Orienteering must also hold a current valid RTA licence appropriate to the vehicle, but the SRs can Permit entries from Drivers who are 16 or over but who do not have a current valid RTA licence for the vehicle, provided their Passenger holds such a licence and is experienced in Cross Country Trials. Furthermore the SRs may permit drivers aged 15 or over where the competitor has finished four TYRO Trials and the vehicle is road legal. The SRs may permit drivers aged 15 or over in a special vehicle (44.1.3) where the driver has finished a further four Cross Country Trials in a road legal vehicle. Proof of finishing may be recorded on the Upgrade Card included elsewhere in this book or other suitable means.

24.3.2. Drivers at Timed Trials must hold a current valid RTA Licence appropriate to the vehicle, exceptionally the SRs may permit drivers aged 16 or over who do not hold a current valid RTA licence appropriate to the vehicle where the competitor has finished four Cross Country Trials.

24.4. The vehicle may only be driven between observed sections by a crew member holding a valid full RTA licence. For Tyro and Junior Trials see 44.1, 25.3 and 45.

24.5. At Hill Rallies both the Driver and Co-Driver or Navigator must produce a valid Competition Licence for those rallies specified in the current chart of Minimum Acceptable Licences as requiring a Competition Licence.

24.6. Upgrading Competition Licences. See H.17.

24.7. Vehicles competing in Cross Country events must comply with Technical Regulations 56 to 63 and J as appropriate.

24.7.1. *Vehicles may be divided into Classes as specified by the SRs.

The Crew

25.1. For Hill Rallies, and Competitive Safaris, all Competitors must wear approved Crash Helmets (K.10), FIA approved FHRs, clothing which covers the arms, legs and torso up to the neck, and unless a windscreen to 57.3.1 is fitted goggles or visors to protect the eyes.

For Timed Trials, Team Recoveries and Point to Point, all Competitors must wear approved Crash Helmets (K.10) clothing which covers the arms, legs and torso up to the neck, and unless a windscreen to 57.3.1 is fitted goggles or visors to protect the eyes.

Additionally competitors in Sports Utility Task Vehicles must wear an FIA approved FHR device, fitted in accordance with FIA regulations.

25.1.1. The wearing of flame resistant clothing and gloves is strongly recommended for all events including untimed events.

25.1.2. The SRs may require crash helmets to be worn in untimed events.

25.1.3. *Seat belts must be worn on all timed events, except Team and Winch Recovery, and are strongly recommended at all events.

25.1.4. Any means of identification fixed for the Competition must be removed when a Competitor retires, is disqualified, or completes the event.

25.1.5. Numbers (2.7.7, 36.4, 50.5.1).

25.2. The same Driver must drive throughout a Competition and except with Official approval, the people carried at the start of an event must not change during the event.

25.2.1. Only the nominated Driver and/or Co-Driver listed on the entry form can drive during a Competition, unless the SRs specify otherwise.

25.2.2. No person under 16 years of age can be carried in an open vehicle during an event and no one is permitted to ride other than in a proper seat.

25.2.3. No Driver may drive for more than 200 miles without rest or relief, either by halting the vehicles for at least one hour or by a change of Drivers (2.5.11).

25.2.4. No competing vehicle may carry more than one physically disabled person, whose participation must be authorised by H.12.

25.3. The minimum age for taking part in a Junior Trial is 8 years.

25.3.1. Competitors are not eligible for Junior Trials on or after their 18th birthday.

25.4. All Competitors must comply with H.7.

Competitors' Regulations: All Events Using the Highway and Hill Rallies

Route Details (33.4, 2.5.11)

26.1. The onus of following the correct route rests with the Competitor who must visit controls in the order set out in the Road Book or Route Card, unless otherwise specified.

26.1.1. A control is considered to extend for 50m around the actual point at which Officials are located, unless clearly visible signs are displayed to define a different area.

26.1.2. The direction of approach to or departure from a control can be specified.

26.1.3. Non-compliance with 25.1.2 requirement by passing a control travelling in the wrong direction, or visiting a control or check more than once, may involve a penalty.

26.1.4. No private road track can be used by Competitors unless specific permission is given in the Road Book or Route Card.

26.1.5. Officials must be on duty at all controls (2.9.4).

26.1.6. If Officials are not present at a control during the whole period when Competitors are due to report, all performances at that control point will be ignored in compiling the results (except as provided for in 2.7.4).

26.1.7. All performances will also be ignored if a control is not sited at the location specified in Official documents.

26.1.8. The onus of ensuring all the required information is clearly and legibly recorded at the appropriate time and place rests with the Competitor (2.9.3).

26.1.9. Should any entry on a Time Card not be legible or not appear authentic, it may be ignored.

26.1.10. Organisers can refer to Marshals' check sheets in case of doubt.

26.1.11. If there is a discrepancy between the time allowance shown by Organisers on the Time Cards and that shown on any other document, the Time Card will be taken to be correct, unless previously amended in an Official bulletin.

26.1.12. It is an offence for any Competitor to proceed or continue in an event until the information required by 2.5.11 is provided.

Rights and Duties of the Organisers

(D.25.1, H.31.1.1, 51.4)

27.1. Judges may be appointed to adjudicate on:

27.1.1. Failure to stop at Stop or Give Way signs.

27.1.2. Failure to comply with 51.

27.1.3. False starts on stage, test or standard sections.

27.1.4. Unauthorised use of auxiliary lights.

27.1.5. Unauthorised possession of recorded notes, radio equipment or intercoms (36.1, 50.3, 51.4).

27.1.6. Unauthorised servicing.

27.1.7. Unauthorised smoking.

27.1.8. Excessive sound (measured by meter) (I.5.17).

27.1.9. Violation of out of bounds areas.

27.1.10. Violation of crash helmet or seat belt regulations.

27.2. Driving Standards Observers (G.11.1 to 11.2) may be appointed to adjudicate on:

27.2.1. Excessive vehicle sound (observed during the event).

27.2.2. Excessive speed.

27.2.3. Driving in a manner likely to bring motor sport into disrepute.

27.3. Any Competitor driving at an excessive speed, in a reckless manner or in a manner likely to bring motor sport into disrepute, or convicted of any driving offence committed during an event, may be disqualified.

SPECTATE SAFELY!

ARI NEEDS YOU TO

Be alert!

Always expect the unexpected

Stay at the designated spectator areas

Remember that in an accident anything can happen

Always follow the instructions of the marshals

Your safety - Your life

ONLY A SAFE RALLY IS A GOOD RALLY

#AriNeedsYou BALLY FUTURE motorsportuk.org

27.4. Checks manned by Judges or DSOs need not be manned for the whole period during which Competitors may report, and may operate on a random basis.

27.4.1. The Official in charge of any control or check may mark or withhold a Competitor's road book, route card or time card if the car concerned has suffered damage to its exhaust system.

27.4.2. *The Organisers may establish a control at any point for the purpose of observing maintenance of a set speed, time schedule or route, provided that the intention to do so is stated in the SRs and Competitors are given all the necessary information for them to comply with the requirements which are to be observed (2.7).

27.4.3. After a Competition has started, Organisers will not accept any claim from Competitors in respect of Force Majeure or baulking (14.6). Despite this, the Clerk of the Course has the right to disqualify any Competitor proven to have unreasonably baulked another.

27.4.4. All Timekeepers will be Judges in respect of time recorded.

Finish – Events Using the Public Highway

28.1. To be classified as a finisher, a Competitor must report to at least two-thirds of the controls listed in the Road Book or Route Card and report to the final control within the maximum lateness specified, with the car in which he started, unless otherwise stated in the SRs.

28.1.1. (28.1) Competitors at the conclusion of their Competition shall sign a declaration form to the effect that they have not been involved in any incident that may have caused damage to persons or property, or alternatively give details of such incident. Failure to comply will be penalised in accordance with 30.1.2(v) or 30.1.1(t) and may be reported to Motorsport UK for further disciplinary action.

28.1.2. Competitors who retire will be required to submit this form to the Secretary of the Meeting within 72 hours of the event.

28.1.3. Failure to return this form may be penalised by a fine of up to £100.

Results – Events Using the Public Highway

29.1. Competitors start with zero marks and classification is based on Competitors who have incurred the least number of marks. Competitors who have incurred an equal number of marks will be classified by reference to total marks lost (30.1.1, 30.1.2).

29.1.1. In the event of a tie, the Competitor who has completed the greater portion of the Competition from the Start (including any tests) without penalty will win.

29.1.2. If both incurred a penalty at the same point, the Competitor with the lesser penalty will be the winner, unless another method of resolving ties is specified in the SRs.

29.2. Damage in relation to 30.1.1(r) or 30.1.2(t) will be considered as being any tear or any indentation exceeding two inches in depth occurring to the external surfaces of the coachwork or accessories (excluding wind-screen, windows, lamps and bumpers) above the horizontal plane of the road wheel centre.

Timing – Events Using the Public Highway

30.1. A Competition must be timed by one of the following methods, which must be stated in the SRs.

30.1.1. Target Timing.

30.1.2. Schedule Timing.

***Target Timing Definitions**

31.1. *Target Time* is the time specified to cover the distance between two consecutive controls.

31.1.1. A Competitor can calculate his Due Time of Arrival at any Time Control by adding the Target Time for the section to his actual time of departure from the preceding Time Control.

31.1.2. When Target Time is used, each period of time must be treated individually and no penalties incurred will apply to any subsequent section.

31.1.3. Lateness taken over Target Time on Road Sections and Special Stages is cumulative and cannot be reduced.

31.2. *Bogey Time* is the time specified for a Competitor to complete a Special Stage without incurring penalty and must comply with 3.11 to 3.12, 11.3.2.

31.3. *Stage Maximum Time* is the maximum time penalty that can be applied on a Special Stage and will be the Target Time for the Special Stage. It must be stated on the Time Card.

31.4. *Cumulative Lateness* is the sum of times in excess of Target Time taken over each section, and once lost cannot be regained.

31.5. *Maximum Permitted Lateness* is the amount of cumulative lateness which if exceeded from the previous Main Control will result in the Competitor being deemed to have retired.

31.5.1. This amount will be 30 minutes (unless the SRs specify a different period).

31.6. *Penalty-Free Cumulative Lateness:* the SRs must specify the amount of cumulative lateness allowed free of penalty before a Competitor is penalised.

31.7. *Dead Time* is that authorised between booking in at the end of one Target-timed section and the commencement of the next section, where that time is spent entirely within a control zone.

31.7.1. Dead Time has no effect on penalties or cumulative lateness incurred elsewhere.

31.8. *Delay Allowance* is a penalty-free allowance granted by an authorised Official to specific Competitors following a delay, and extends the Target Time for those Competitors on that section only.

31.8.1. Any delay allowance must be recorded in writing on a Competitor's time card by the Official.

31.9. A *Main Control* is situated at the Start and Finish of a Rally, immediately before and after any Rest Halt, and at any other specified point.

31.9.1. At a Main Control after a Rest Halt, Competitors will (unless the SRs specify otherwise) restart at one minute intervals.

31.9.2. They do so by one of the following methods, which must be specified in an Official Instruction:

- (a) In number order
- (b) In the order of their arrival at the Main Control preceding the Rest Halt
- (c) In the order of their arrival at some other preceding control, or
- (d) In the order of General Classification at a specified point if interim results are available.

31.9.3. Each Competitor must be given a due starting time from any Main Control (Out), and any difference between this time and the Competitor's actual starting time will be counted towards cumulative lateness and a Time Penalty applied (unless the SRs specify otherwise).

31.10. *Re-grouping Controls:* the Road Book or Route Card can specify any controls that relate to Competitors who are considered to have retired through having accumulated more than the maximum Permitted Lateness at a control.

31.10.1. These Competitors commence the next section with zero lateness towards disqualification.

31.11. In a *Special Stage Arrival Control*, a Competitor proceeds to the Special Stage Start immediately after checking in to the Special Stage Arrival control. The area between the Special Stage Arrival Control and the Stage Start must be Parc Fermé.

31.12. Similarly in a Special Stage Finish Control, a Competitor receives a Special Stage Finish Time in hours, minutes and seconds at the Special Stage Finish Control. This time (in hours and minutes) is used as the start time for the next section (unless the SRs specify otherwise).

31.13. Competitors will receive penalties on Special Stages as follows (unless the SRs specify otherwise):

Under Bogey Bogey Time

Over Bogey under Target Actual Time taken

Over Target Target Time.

Scheduled Timing Definitions

32.1. *Standard Time* is the time of day a notional Competitor number zero would be due at any control or check.

32.2. *Scheduled Time* is the actual time each Competitor is required to be at any specific point and can be calculated for any point by adding that Competitor's Competition number, multiplied by the time interval between Competitors at the Start, to the standard time at that point.

32.3. *Delay Allowance* is a penalty-free allowance granted by an authorised Official to specific Competitors following a delay.

32.3.1. It must be recorded in writing on the Competitor's time card by the Official.

32.4. *Due Time* is the time a Competitor is due at any control or check, inclusive of any previous lateness.

32.5. *Penalised Time* is the difference between Due Time and an earlier or later arrival time.

32.6. *Penalty Free Lateness* allows a Competitor late at one control to be an equivalent amount late at the next control without incurring further penalty.

32.7. *Maximum Time* is the latest time a Competitor can arrive at a control or check without incurring further penalty.

32.8. *Outside Total Lateness (OTL)* is the point where a Competitor is considered not to have visited the control or check by virtue of the fact that they are more than 30 minutes past their Scheduled Time (including any delay allowance).

32.8.1. The SRs can specify a different period.

33.1. Organisers may require any Competitor who is late to reduce their lateness by either foregoing or reducing any period provided for remaining at a control or Official halt. Competitors may themselves reduce lateness without penalty in the following ways (providing the Section is not defined as Neutral (3.4 and 3.5) and unless forbidden to do so by the SRs or by breaching 33.4):

33.1.1. When Target Times are used, by traversing the distance between any two or more points in a time less than the Target Time, so long as they do not report at a control or check before the original Scheduled Time.

33.1.2. By reporting at any control or check following one at which a penalty was applied for lateness at any time not earlier than Scheduled Time.

33.1.3. A Competitor on any Rally without Special Stages who wishes may miss a Control or Controls. They will be penalised in accordance with 30.1.2(a) or 30.1.1(a) for every control missed. If they rejoin the route at a control at the end of Standard section, they will be Permitted to restart without further penalty at any time between their original Scheduled Time and their Maximum Permitted Lateness in relation to their original Scheduled Time. If rejoining control at the end of a Neutral section, they will only be Permitted to restart without further penalty at their Official Corrected Time based on the time of arrival at the last control at which they reported.

33.2. If the need arises for an Organiser to extend Maximum Permitted Lateness, this can only be done at a point on the route at which Competitors are required to report to avoid disqualification.

33.2.1. Maximum Permitted Lateness can then only be extended for the following part of the route and cannot be applied retrospectively for earlier sections.

33.2.2. These provisions are subject to Standard Condition 4 of the Motor Vehicles (Competitions and Trials) Regulations where they apply.

33.3. No penalty free lateness or Official delay allowance which has been either reduced or foregone as Permitted by 33.1 can be reclaimed.

33.3.1. This does not exclude fresh claims based on new circumstances.

33.4. A Competitor found to have traversed a distance greater than four miles between two consecutive time controls in less than three-quarters of the time specified by the Official time schedule will be penalised in accordance with 33.1, unless competing on a special stage. In calculating such a penalty, any fraction of a minute will be ignored. Thus:

33.4.1. In a nine minute section a penalty is imposed if a Competitor completes the section in less than six minutes.

33.4.2. In a 10 minute section – seven minutes.

33.4.3. In an 11 minute section – eight minutes.

33.4.4. In a 12 minute section – nine minutes.

34.1. Any timing to less than one minute will be recorded on equipment as detailed in 2.13.

34.1.1. Competitors will be timed by the Official timepieces in the charge of Officials, unless the SRs state that watches carried by the Competitors can be used.

34.1.2. *If Competitor's own watches are used, they must be of a size and type to enable the dial to be read and must be sealed.

34.1.3. The requirements for sealing watches must be stated in the SRs.

34.1.4. The promoters may reject any watch which cannot be satisfactorily sealed or read.

34.1.5. If any sealed watch varies from Official time by more than one minute, the Competitor concerned will be timed by Official clocks from then, unless the SRs make provision for the replacement or re-setting of the watch concerned.

Controls – All Events using the Public Highway and Hill Rallies (2.4 to 2.6, 26)

35.1. Controls, checks and test sites must open 30 minutes before the due time of arrival of the first car, and close 30 minutes after the due time of arrival of the last car, unless the SRs specify otherwise.

35.1.1. The time of arrival at or departure from a control, other than intermediate and final controls of Regularity Sections (where 35.1 applies), will be the time at which the Road Book or Time Card is presented by the Competitor concerned, providing all crew members and the car are within the control area.

35.2. Exceptions to this are:

35.2.1. In the event of a competing car obstructing other Competitors through being halted or unduly slow near a control, Officials may instruct the Driver to proceed and may then record the time as the time when this instruction is given.

35.2.2. In the event of a Competitor presenting a Time Card to Officials at a time when the car is outside the control area, the Officials may or may not make a record on the Time Card at their discretion.

35.2.3. At Special Stage Arrival Controls, no penalty will be incurred if the car enters the control area as follows:

(a) On a Target Timed event, the car may enter during the sixty seconds immediately preceding the target check-in minute, or during the check-in minute. (For example: a car has left the previous Stage Finish at 11.04.40 on a section for which the target time is nine minutes. It is therefore due at the next Time Control at 11.13. The car arrives at the yellow advance Control Board at 11.08, stopping before the yellow board. The car is Permitted to enter the control zone at any time after 11.12.00. The Time Card may be handed in at any time between 11.13.00 and 11.13.59, and a time of 11.13 will be recorded. This procedure will incur no penalty.)

(b) On a scheduled time event, the car may enter the control zone during the sixty seconds immediately preceding the due time minute, or during the due time minute. The procedure to be followed is identical to that for a target timed event from the point of arrival at the yellow control board to the actual check in time.

35.3. The responsibility of establishing the correct Due Time rests solely with the Competitor, as does the onus of presenting the Time Card.

35.3.1. The time of reporting at controls will be recorded to the preceding whole minute when penalties are imposed per minute (eg 09 minutes 59 seconds will be recorded as 09 minutes).

35.3.2. When a penalty is imposed for a timekeeping error of less than one minute, the time will be recorded to the preceding second.

35.3.3. Where a control at the end of a section timed to the second also forms the start of a section timed to the minute, the time of departure will be considered as being the same as arrival, but ignoring any seconds.

All Events except Hill Rallies Using the Public Highway (2.9)

36.1. Competitors must not carry any form of Intercom (ie any method of voice amplification) or any radio transmitting device. Penalties are specified in 30.1.2(u) or 30.1.1(s).

36.1.1. Exceptionally, mobile telephones are Permitted if the SRs specifically allow them.

36.1.2. No regular assistance organised in advance may be used by Competitors.

36.2. Competitors must stop before entering any road protected by a Stop or Give Way sign. Failure to do so will be penalised as in 30.1.2(v) or 30.1.1(t) (4.3.1).

36.2.1. Exceptionally, with the specific permission of the RLO, Give Way signs in Quiet Zones may be negotiated in accordance with the Highway Code.

36.2.2. Any such junctions must be advised to Competitors in advance.

36.3. Only 1:50,000 scale OS maps may be used. The only information which can be added to these maps as sold is:

36.3.1. Highlighting numbers, words and legends printed on the map within the outer printed grid numbers.

36.3.2. Highlighting and repeating grid lines and numbers, and marking adjacent map numbers outside the area defined above.

36.3.3. Including information provided by the event Organisers.

36.4. If required by the Organisers, Rally plates must be displayed at the rear of the car and on, or just below, the rear side window (3.4.1, 2.7).

36.4.1. Competitors are strongly recommended to carry a First Aid Kit.

Regularity Sections (3.6)

37.1. Timing will be at the moment of entering the control area. The SRs will specify:

37.1.1. Whether Competitors need to stop and present Time Cards at intermediate controls.

37.1.2. *The penalties for stopping within sight of any control.

37.1.3. *The penalties for early or late arrival at any control on a Regularity Section.

Route Checks

38.1. These unmanned checks prove a Competitor's stays on the correct route.

38.1.1. Proof of passage will involve recording the symbols from a Code Board which must be placed facing oncoming Rally cars.

38.1.2. The Code Board will at least 315 sq cm and show a maximum five black numbers or letters (or a combination of both up to a maximum of seven) on a contrasting background.

38.1.3. The letters/numbers must be at least three inches high (7.63 cm) with a minimum of 1/2 inch (1.27 cm) stroke width.

Passage Controls

39.1. Manned Passage Controls also prove a Competitor's adherence to the correct route.

39.1.1. Passage Controls cannot be located less than 500m from any other manned control.

39.1.2. The only requirement for a Competitor is to have the Marshal's signature recorded.

Time Controls

40.1. Time Controls are manned points established to record the time of a Competitor who must come to a stop for the purpose.

40.1.1. It can additionally record the direction of the Competitor's approach and departure.

40.1.2. The only other information Permitted to be recorded by the Marshal is the authentication of the records held by the Competitor.

40.1.3. These records, to be valid, must be signed by the Marshal with the Competitor not being required to make any entry on the time card.

40.1.4. An example of all Official boards must be on display at documentation for the event.

Competitors' Regulations: Trials and Un-Timed Events

Cross Country Vehicle Trials (5)

41.1. These must be organised in accordance with paragraphs 24 to 40 as appropriate.

41.1.1. *The SRs may allow the vehicle crew to be varied during the event and may specify the minimum tyre pressure permitted for the Competition.

41.1.2. Only one Passenger aged 16 or over may be carried on a vehicle during Observed Sections.

41.1.3. Exceptionally, the SRs may reduce this minimum age to 14, providing the vehicle is fitted with seat belts and either a manufacturer's hard top, a truck cab, or a rollbar, or where the vehicle is a road legal, mass produced, production vehicle retaining the original hardtop or truck cab and where the seat belts comply with K2.1.1, the SRs may further reduce the minimum age of the passenger to 12.

41.1.4. The Passenger must remain properly seated alongside the Driver throughout all Observed Sections.

41.1.5. 'Bouncing' will be Permitted only within the confines of the seating compartment, and then only so long as no portion of either the Driver's or Passenger's body (other than arms and hands) is placed outside the sides of the vehicle or behind the seat they are occupying.

Numbers

41.2. Numbers will be allotted by ballot.

41.2.1. Numbered Results Cards will be issued at the Start and must be presented by the crew to Officials.

41.2.3. Competition numbers must be displayed on both sides of all competing vehicles, except for Trials when the SRs may relax this requirement.

41.2.4. Competitors will start in numerical order, and the Organisers shall determine the order of running at each observed section.

41.2.5. Competition Numbers or Number Cards must be removed at the Finish or if a Competitor retires.

Observed Sections and Route

42.1. The onus of following the correct route rests with the Competitor.

42.1.1. Any signs displayed, other than in an Observed Section, are designed to assist Competitors and have no mandatory authority, unless the SRs specify otherwise.

42.1.2. Competitors will drive from point to point with as little delay as possible, and any Competitor suspected of loitering can be ordered to proceed by an Official.

42.1.3. Competitors arriving at an Observed Section more than 20 minutes after the preceding Competitor may be refused permission to attempt that section.

42.2.1. *Competitors should attempt to negotiate Observed Sections without stopping.

42.2.2. Organisers may, however, allow certain vehicles, by virtue of their size, to take a specified number of changes of direction on any particular section.

42.2.3. The permission to change direction and the eligibility of vehicles to do so must be specified in the SRs or Final Instructions (see Appendix 1, drawing number 204).

42.3. Failure of a vehicle to maintain unassisted forward motion in the direction of the course will be regarded as failure to comply with the requirements to proceed non-stop, unless the Judges are satisfied that a Permitted change of direction is intended, or the Organisers have ruled that more than one attempt may be made.

42.3.1. The point of failure will be at a vertical line from the centre of the hub of the front wheel which is the farther from the start of the section.

42.3.2. The beginning of any Observed Section will be marked by signs and its boundaries by markers or natural obstacles.

42.3.3. Natural obstacles must not be used as penalty markers.

42.4.1. Before attempting an Observed Section, a vehicle must be brought to rest with a leading wheel hub centre vertically over the Start line, as indicated by Officials.

42.4.2. The Driver must not proceed until instructed to do so.

42.4.3. If an Observed Section is divided into Sub-Sections, signs must indicate the beginning and end of each Sub-Section.

42.4.4. A vehicle will be considered to have entered an Observed Section or Sub-Section when the leading wheel hub centre has passed the marker(s) indicating the beginning of the section.

42.4.5. A vehicle will be considered to have left an Observed Section or Sub-Section when the leading wheel hub centre is past the marker(s) indicating the end of the section, provided that no prior penalties have been incurred.

42.4.6. *Failure in a lower or earlier Sub-Section will constitute failure in all succeeding Sub-Sections.

42.5. The Start line will indicate the greatest penalty and the Finish line the zero penalty. The SRs will specify the methods of scoring and application of penalties.

42.5.1. A Competitor will be deemed to have failed to negotiate an Observed Section non-stop if:

42.5.2. Any part of the vehicle touches a penalty marker, and/or

42.5.3. All wheels cross the boundary of the course as defined by the Clerk of the Course.

42.6.1. The point of failure will be deemed to be that at which the first penalty marker is touched, or the point at which the course boundary is first crossed by all wheels of the competing vehicle.

42.6.2. Should this point of failure coincide with the division between two Sub- Sections, the marks lost will be those on the Sub-Section recording the greater penalty.

42.7.1. Performances on any Observed Section may be ignored at the Organisers' discretion, even though there have been successful attempts to negotiate the section.

42.7.2. If this discretion is exercised, no performance on the section in question must be taken into account when compiling the results.

42.8. No unauthorised assistance is allowed and vehicles must complete the course under their own power. No case of force majeure will be taken into consideration.

42.9. At the Organisers' discretion, a minority of the Observed Sections may be timed, if provided for in the SRs. The following conditions will apply:

42.9.1. Only those sections which the Organisers anticipate will be completed without penalty by the majority of Competitors may be timed.

42.9.2. Any such timed section must be less than 200m long.

42.9.3. No Sub-Sections of an arduous or demanding nature can be used.

42.9.4. The maximum time allowed for each timed section must be stated in the Official Instructions prior to the commencement of the test.

42.9.5. The maximum time allowed for each timed section must not require any Competitor to exceed 15mph or 30 seconds per 200m.

Results – Trials

43.1. Any penalties incurred on a timed section must be calculated by reference to the following formulae, unless the SRs specify otherwise.

43.1.1. For failing to proceed non-stop. Where the 12* failure will decrease in proportion to the number of Sub-Sections negotiated non-stop.

43.1.2. For successfully negotiating the section 0 within the time allowed.

43.1.3. *Plus the highest penalty incurred by any Competitor making an attempt correctly.

43.2. For negotiating the section non-stop in excess of the time allowed the following formula is used:

Time taken x 100 – 100 = Time allowed Penalties

Penalty points		Penalty points	
0.0 – 8.3	1	50.1 – 58.3	7
8.4 – 16.6	2	58.4 – 66.6	8
16.7 – 25.0	3	66.7 – 75.0	9
25.1 – 33.2	4	75.1 – 83.3	10
33.3 – 41.6	5	83.4 – 91.6	11
41.7 – 50.0	6	91.7 – 100.0	12
		100.0 & above	12

43.3. Competitors will start with zero marks. To be classified as a finisher, a Competitor must have attempted at least three quarters of the total number of Observed Sections and arrive at the Finish within 20 minutes of the preceding vehicle.

43.3.1. The Competitor incurring the lowest marks will be the winner, and so on.

43.3.2. Ties will be resolved at the Organisers' discretion, unless the SRs state otherwise.

43.3.3. Each Competitor will be provided with a Results Card which must be produced on demand for Officials to mark at each section, unless the SRs specify an alternative method.

43.4. Penalty marks will be incurred as follows, unless the Marks Lost indicated below are modified by the SRs:

Penalty	Marks Lost
Each minute late reporting at the Start or a re-Start	5
Failure in an Observed Section (where an Observed Section is divided into	12
Sub-Sections the penalty for failure will decrease in proportion to the number of Sub-Sections negotiated non-stop)	
Not attempting or being ready to attempt an Observed Section or Sub-Sections when instructed to do so	12*
Not complying with a reasonable instruction by an Official for which a penalty is not otherwise stipulated, and provided warning of penalty is given	12*
Driver and/or Passenger not seated in accordance with 41.1.4	12
Running with tyre pressures lower than that required by SRs	50

*Plus the lowest total penalty incurred by any Competitor making an attempt correctly.

Tyro Trial (7)

44.1. Tyro Trial Drivers must hold a valid RTA licence (not provisional) for vehicles with more than three wheels and produce a valid Club membership card.

44.1.1. The SRs may Permit entries from Drivers who are 13 or over without a full RTA Licence, provided that their Passenger has experience of Cross Country Trials and holds a full RTA Licence for the vehicle entered.

44.1.2. The vehicle may only be driven between observed sections by a crew member who holds a valid full RTA Licence.

44.1.3. Vehicles not complying with 62 must be fitted with a standard manufacturer's hardtop, truck cab or a roll bar to Section K, Appendix 2, drawing 1, and the SRs may permit entries to be accepted in respect of drivers who are 15 or over without a full RTA licence provided that the passenger holds a full RTA licence valid for the vehicle concerned and is a person who has experience of Cross Country Trials.

44.2.1. More than one Passenger may be carried where the Driver holds a valid full RTA Licence.

44.2.2. Passengers under the age of 18 will not be considered as Competitors for the purpose of licensing or Club membership and will not be required to sign on. They will however be required to produce at signing-on a letter of consent from a parent or guardian which must be retained by the Organisers.

44.2.3. All passengers must be properly seated with their seat back in an upright position and the seat adequately fixed.

44.2.4. All occupants must wear an approved seat belt at all times and all passengers must be seated in forward facing seats. Their seat back must be upright and they must face forwards.

44.2.5. The passenger sitting alongside the Driver during sections must be at least 12 years.

44.2.6. Passengers who occupy the rear seats of the vehicle must not be less than 2 years of age, any child under 12 years of age or 135cm in height must be seated using an approved 'child restraint'.

Junior Trial

45.1. Junior Trials must be organised in accordance with 24 to 35, 27.1, 28.1, 42 to 43.

45.1.1. At all times during a Junior Trials event vehicles may only be driven under the instruction of an Official.

45.1.2. There are three Classes of Trial: Novice, Intermediate and Expert.

45.1.3. Competitors must finish four Novice Junior Trials before being eligible for Intermediate Junior Trials, and four Intermediate Junior Trials before entering Expert Junior Trials.

45.1.4. Proof of finishing a Junior Trial will be by the signing of a Competitor's Competition Licence by the Clerk of the Course.

45.2.1. Sections for the different Classes may either be set out separately or so that a section increases in severity with separate finishing points for the respective Classes.

45.2.2. Fiddle brakes may only be used by Competitors in the Expert Class. If fitted to vehicles entered in Novice or Intermediate Classes they must be rendered inoperative.

Winch Recovery (8)

46.1. The following regulations are additional to and take precedence over 24 to 35.

46.1.1. Details of the course, the manner of recovery, the maximum time for completion and the method of starting will be given at the Start.

46.1.2. Competitors will be allowed to examine the course prior to the start.

46.2.1. *The SRs will specify the number of vehicles and members in a team.

46.2.2. No more than three members will be allowed in each team which must nominate a Captain to be responsible for keeping any score-card issued and represent the team to the Clerk of the Course.

46.3.1. *At the Start and Finish, all team members must be correctly seated in their vehicle and all equipment must be in or on the vehicle.

46.3.2. Each team will be allowed a minimum of two attempts at the course.

46.3.3. The team completing the course with the least penalties as stated in the SRs will be the winner.

46.4.1. The Clerk of the Course may penalise or stop a team if it is considered their mode of recovery is likely to be dangerous to Officials, Competitors, spectators or natural terrain.

46.4.2. The Clerk can also award penalties for touching gates.

46.4.3. Once a winch vehicle and anchor vehicle have been manoeuvred into position, they must remain stationary whilst winching.

46.4.4. Natural anchorage points may be used, but must be protected from damage.

46.4.5. It is strongly recommended that all members of the team wear protective clothing during winching operations, ie overalls, gloves, eye protectors.

46.4.6. It is strongly recommended that competitors, other than the winch operator, should also wear a crash helmet to Motorsport UK specification.

46.4.7. All equipment, including cables, ropes, straps or webbing, shackles, blocks, hooks, ground anchors, winches, etc and vehicles must be presented to, and approved by, the Scrutineer prior to an event.

46.4.8. The Organisers may supply certain equipment.

Promotional Events (9)

47.1. Drivers must hold a valid RTA Licence (not provisional) in respect of vehicles having more than three wheels.

47.1.1. The SRs may Permit entries from Drivers who are at least 16 without a full RTA Licence, provided the Passenger holds a valid full RTA Licence and has experience in Cross Country Trials.

47.1.2. The vehicle may only be driven between Observed Sections by a crew member who holds a valid full RTA Licence.

47.2.1. All Drivers must produce a valid Club membership card.

47.2.2. More than one Passenger may be carried where the Driver holds a valid full RTA Licence.

47.2.3. Passengers under the age of 18 will not be considered Competitors for the purpose of Licences or Club membership and will not be required to sign on.

47.2.4. Passengers under the age of 18 will however be required to produce at signing-on a letter of consent from a parent or guardian, which must be retained by the Organisers.

47.3.1. All Passengers must be properly seated with the seat back in the upright position and with the seat adequately fixed.

47.3.2. All occupants must wear an approved seat belt at all times.

47.3.3. The passenger sitting along side the driver in sections must be at least 14 years of age.

47.3.4. Passengers who occupy the rear seats of the Vehicle must not be less than 2 years of age, any child under 12 years of age or 135cm in height must be seated using an approved 'child restraint'.

47.3.5. Passengers may not be carried for hire or reward.

Competitors' Regulations: All Timed Events

Cross Country Vehicle Timed Trials (10)

48.1. The following regulations are additional to and taking precedence over paragraphs 24 to 35, 27.1, 28.1 and 41 to 43:

48.2. Penalties will be in accordance with the following:

48.2.1. For each second over the Target Time: 1 mark per second.

48.2.2. For failing to satisfactorily negotiate an Observed Section within the maximum time allowed: 1 mark per second of maximum time allowed.

48.2.3. The SRs may specify additional penalties based on a specified number of marks per second.

48.3.1. Failure of a vehicle to maintain unassisted forward motion in the direction of the course will not be regarded as failure to comply with the requirements to proceed non-stop.

48.3.2. Further attempts to regain forward motion will be Permitted until the maximum time allowed for the section has elapsed.

Competitive Safaris (11)

49.1. These regulations are additional to and take precedence over paragraphs 24 to 35, 27.1, 28.1 and 41 to 43.

49.1.1. *The SRs may Permit two separate Drivers to drive one vehicle under one entry. In such cases their total combined penalties will be added together as if they were one Competitor.

49.1.2. Vehicles may carry one passenger, minimum age 16, in addition to the Driver, who must be seated in accordance with the provisions of 41.1.5.

49.2. It is recommended that crew are identified by suitable means, eg a rubber stamp or a plastic wrist identity tag, which must be issued at signing-on.

49.2.1. This must not be re-usable and must not cause discomfort.

49.2.2. For safety reasons it must be worn under clothing.

49.2.3. Each Competitor must be allowed to choose to which limb the identity mark is applied.

49.2.4. Competitors will be required to show the identity marking to Officials in the assembly area prior to the Start line.

49.3. (1.4) Competition numbers must be displayed on both sides of each vehicle, either on the front doors or behind them above the vehicle waistline and parallel to the vehicle sides.

49.3.1. Where the SRs require numbers to be displayed at the front or rear of a vehicle, they must be a minimum 100mm in height.

49.4.1. Competitors will be advised of the minimum and maximum time allowed for the course, before the Start.

49.4.2. The course should have a clearly marked route so that no navigation is required, and all course markings should comply with the provisions of 11.9 to 11.14.

49.4.3. Practising will not be allowed over the course, unless the SRs state otherwise. If Permitted, the SRs must specify the number of practice runs and the times of any practice periods (11.8.3).

49.5. The SRs must also specify:

49.5.1. *The number of competitive runs.

49.5.2. *The time interval between vehicles leaving the Start line, and whether the Organisers may hold Competitors en route in the event of the course becoming blocked. In such instances allowance will be made for the time Competitors are delayed.

49.5.3. *The method by which Competitors are signalled to stop and whether re-runs will be Permitted.

49.5.4. *The starting signal and method of timing to be used.

49.6. *Competitors will be required to proceed over the course in the shortest possible time.

49.6.1. The SRs will specify whether Live Recovery will be operated by Specialist Recovery Vehicles (SRVs) at the event.

49.6.2. These should be positioned at points where Competitors are likely to make involuntary stops.

49.6.3. The SRs will specify the maximum time allowed to Competitors for self recovery, after which they must take Official recovery.

49.6.4. No recovery operations organised by the Competitor in advance may be used.

49.6.5. At events where Live Recovery is operated, the Clerk of the Course must advise Competitors of the procedures at the Drivers Briefing.

49.6.6. The Clerk of the Course must specify whether the SRVs will be manned by a third crew member responsible for attaching the tow rope, or whether this will be carried out by the passenger or navigator. In the former case, Competitors must remain in the vehicle and follow the instructions from the SRV crew. In the latter case, the passenger or navigator must alight from the stranded vehicle and follow the following procedure:

- (a) They must stand clear and await instruction from the first crew SRV member before attaching the tow rope between the vehicles
- (b) When properly attached to the towing points, they must stand clear and indicate to the first SRV crew member that Live Recovery may start
- (c) Once the stranded vehicle has been recovered, and only after the first SRV crew member has indicated that it is safe to do, they can detach the tow rope and stow it safely. They should then inform the first SRV crew member that the course or stage can be cleared
- (d) The Driver of the recovered vehicle must not proceed until the Passenger or Navigator involved is properly seated and belted in. Failure to comply will be penalised by disqualification.

49.6.7. When arriving at a point on the course or stage where a Yellow Flag is being displayed, the Competitor must not pass the Yellow Flag unless instructed to do so by a Marshal and will proceed with caution until clear of the incident, obstruction or stranded vehicle.

49.6.8. Failure to comply will be penalised by disqualification.

49.6.9. Time lost whilst Live Recovery of another Competitor is in progress will be regarded as force majeure (27.4.2).

49.7. Unless the SRs specify otherwise penalties will be awarded as follows:

49.7.1. For each second to complete the course over minimum time allowed: 1 mark per second.

49.7.2. For exceeding the maximum time allowed: disqualification.

49.7.3. For taking Official recovery: 100 marks.

49.8. Competitors must carry an A4-size white board with a red SOS on one side and black OK on the other (letters to be a minimum of 12cm high with a minimum stroke width of 1.5cm), with means to secure them on display for oncoming Competitors.

49.8.1. In the case of an accident where urgent medical attention is required, the red SOS sign should be displayed as quickly as possible to alert following cars and aid any helicopter attempting to assist.

49.8.2. Any crew that sees a red SOS sign displayed on a car, or sees a major accident where both crew members are inside the car but not displaying the SOS sign, must immediately and without exception stop to give assistance.

49.8.3. All following cars must also stop and the second car arriving at the scene must inform the next radio point.

49.8.4. Subsequent cars must leave a clear route for emergency vehicles.

49.8.5. The Clerk of the Course may award a discretionary time to any Competitor delayed in such circumstances.

49.8.6. Any crew which is able to but fails to comply with the rule will be reported to the Clerk of the Course who may impose penalties.

49.8.7. In the case of an accident where medical intervention is not required, the OK sign must be clearly shown to following vehicles, and to any helicopter attempting to assist.

49.8.8. If the crew leave the vehicle, the OK sign must be left clearly visible to other Competitors.

49.8.9. Any crew failing to comply will be subject to a penalty at the Clerk of the Course's discretion.

49.8.10. Competitors who misuse the SOS or OK signs will be penalised and may be reported to Motorsport UK for further action.

49.9. Any crew retiring from an event must report to the Organisers as soon as possible, except in cases of force majeure.

Hill Rallies [82-124]

50.1. The following regulations are additional to and take precedence over paragraphs 14 to 19 and 24 to 49:

50.1.1. Trials-type sections or tests may be incorporated in special stages and should be marked in accordance with the standard procedures for CCV Trials or Autotests.

50.1.2. Competitors must be advised of the average speed which will be applied on special stages. At no time will Competitors be required to average in excess of 50mph.

50.1.3. Each car must carry at least one Passenger (Navigator/Co-Driver) as well as the Driver.

50.1.4. Servicing issues are covered in 50.6 to 50.9.

50.1.5. No assistance may be expected from the Organisers even though they may give advice as to the source of supplies. Competitors are responsible for their own fuel, oil, water etc.

50.1.6. No vehicle may be moved other than by its own power except:

- (a) By a ferry
- (b) By outside means for a minimum distance necessary to extricate it from difficulty
- (c) By gravity
- (d) By its crew.

50.2. During the course of an event Competitors are not permitted to use, or be directly or indirectly concerned in the use of, helicopters or fixed wing aircraft in the vicinity of the event (whether in connection with servicing, aerial surveillance or for any other reason) without previous Motorsport UK authorisation in writing, and in compliance with CAA regulations (E.2.2.6).

50.2.1. Before considering any such authorisation, Motorsport UK must be satisfied that the liabilities of all those involved in the event have been covered.

50.2.2. Any such application must be made at least 14 days prior to an event.

50.2.3. In accordance with CAA regulations, no aircraft is allowed within 500ft of the route, or within 3,000ft of any large crowd.

Competitors

50.3.1. Competitors and their service personnel may only use radio transceiver equipment (and frequencies) that are licensed in accordance with Ofcom Regulations.

50.3.2. Competitors must not use or carry any radio Transmitting device which operates on, or interferes with, the Motorsport UK's Licensed Frequencies.

50.3.3. Contravention of these regulations will be penalised in accordance with 30.1.2(v) or 30.1.1(t).

50.4.1. All Drivers' and Co-Drivers' crash helmets and overalls must be produced for approval during scrutiny of a vehicle.

50.4.2. All crew members must wear a crash helmet bearing an MSA/Motorsport UK approval sticker (see K.10) and a safety belt throughout any Special Stage.

50.4.3. Crew members must not smoke during any stage or test.

50.4.4. Drivers must conform to the Medical Requirements specified in H.10.

50.4.5. No person under 16 years of age may be carried during a rally with Special Stages.

50.4.6. Competitors must comply with any instructions in the Road Book concerning stopping at road junctions. Failure to do so will incur penalties as in 30.1.2(o) or 30.1.1(m).

50.5.1. Competition numbers must be displayed on both sides of the vehicle, behind the front doors and above the vehicle waistline, and parallel to vehicle sides.

50.5.2. Rally plates at the front and rear will display Competition numbers with a minimum 100mm height.

50.5.3. On Multi-Use Hill Rallies these will be at the Organiser's option.

50.6. *Organised assistance (service) may be allowed on Hill Rallies if provided for in the SRs, and providing the Organisers have made available suitable service areas and a specific time allowance for servicing.

50.6.1. *Organised assistance anywhere other than in permitted areas is forbidden.

50.6.2. Service vehicles may be required by the SRs or the Official Instructions to follow a prescribed route to and from service areas. In such cases all other areas are Out of Bounds for service vehicles and their crews.

50.6.3. In any area where service is not allowed, the presence of a service vehicle (or any vehicle from which equipment or parts are obtained) or the collection of equipment previously deposited, will be considered as servicing.

50.6.4. These regulations do not prohibit Organisers advising Competitors of any garages en route where facilities are available.

50.7. The above regulations do not prevent Competitors from personally making their own vehicles safe to drive. Crews may work unassisted on their own cars, using equipment carried in their car, in 'No Service Areas' except:

50.7.1. Within 100m of any Control.

50.7.2. Between a Special Stage Arrival Control and the Special Stage Start Control.

50.7.3. In any Parc Fermé.

50.8. The only work Permitted in these areas (and it must be unassisted) is:

50.8.1. Replacing a flat tyre with a wheel and tyre carried in the competing car.

50.8.2. Cleaning lamp glasses, windscreens, windows, identification markings and vehicle registration numbers.

50.9.1. Except in the areas listed above, Competitors may work on their cars with the assistance from other Competitors, from any nationally recognised breakdown service, and from any commercial garage not associated with the Entrant and not organised in advance.

50.9.2. Breakdown service and commercial garage vehicles will not be allowed to enter Official service areas.

50.9.3. Competitors are responsible for ensuring that their service crews understand and comply with these regulations, and if Official Service Plates are issued, that the service vehicles at all times bear the Official Service Plate.

50.9.4. A Competitor may be fined or otherwise penalised by the Clerk of the Course if the crew of any service vehicle associated with their entry contravenes any regulation or Official instruction, or acts in a manner contrary to the interests of the event.

50.9.5. Competitors may be fined, but not otherwise penalised, for any breach of Road Traffic Laws by their service crews.

50.9.6. Competitors are strongly recommended to carry a First Aid Kit.

Special Stages

51.1. During any special stage or test the prescribed route must be followed, and any direction signs displayed are mandatory.

51.1.1. Competitors overshooting the stop line at the end of any stage or test are not allowed to reverse back to the Control.

51.1.2. Competitors are also not allowed to cross any part of a Special Stage in the opposite direction to rally traffic.

51.1.3. Competitors must not voluntarily leave the prescribed route without the express permission of the Stage Commander.

51.2.1. Any Competitor who is shown a Red Flag on a stage where they have been notified in advance of a Red Flag system must cease competition immediately and come to a standstill at the side of the course as soon as possible.

51.2.2. They must not proceed until advised to do so by an Official (14).

51.2.3. Competitors may only attempt a Special Stage once. Re-runs are not permitted (14).

***51.3.** Following instruction from a Stage Start Marshal that they are next to start on a Special Stage, Competitors abide by the following procedure:

51.3.1. The Marshal should give a loud verbal indication 30 seconds, 15 seconds, 10 seconds and 5 seconds before the actual start, and then countdown verbally each second 5-4-3-2-1-GO.

51.3.2. Upon the signal GO, a visual starting signal must be given which will normally be the raising of a flag from the bonnet (not the windscreen).

51.3.3. Any other visual signal to be used must be described in the SRs.

51.3.4. Making a false start will be penalised in accordance with 30.1.2(h) or 30.1.1(h).

51.3.5. Stages where Competitors are required to start at intervals of less than one minute may dispense with the 30 seconds advance warning. This revised procedure must be advised in the SRs.

51.4. Unless the SRs state otherwise, the use or possession of pace notes or any other means of giving a Competitor advice relating to the traversing of a Special Stage which has not been provided by the Organisers is forbidden (27).

Motorsport UK House

OPEN
Monday–Thursday
9.30–5.30

Friday
9.30–5.00
(phone enquiries
10.00–5.00 please)

Tel: 01753 765000
Fax: 01753 682938

Licence Section:
Tel: 01753 765050
Fax: 01753 685426

Website:
www.motorsportuk.org

51.4.1. This does not preclude the use of Ordnance Survey maps of 1:25,000 or 1:50,000 scale in addition to others that are specified in the SRs.

51.4.2. The only supplementary information which may be shown on the maps is information given by the Organisers of the event (including route details).

51.4.3. Contravention will be penalised as in 51.5.

51.5. Deleted.

Team Recovery (21)

52.1. The following regulations are additional to and take precedence over 24 to 35, 27.1, 28.1 and 41 to 43.

52.1.1. *The SRs will specify the number of vehicles comprising a team.

52.1.2. Teams will start in numerical order, and the Organisers will determine the order of running at each Observed Section.

52.1.3. Details of Observed Sections must be given at the Start and unless the SRs specify otherwise, teams will have the opportunity of inspecting the course before attempting each Observed Section.

52.2.1. Team Members may start in any order.

52.2.2. Each team will nominate a captain, who will be responsible for carrying the Official score card for the team, and who will produce it on demand to Officials.

52.2.3. Team vehicles must not be harnessed together before the start.

52.2.4. The onus of following the correct route will rest with the Team Captain.

52.3.1. No Passengers can be carried in any team vehicle when it leaves the Start.

52.3.2. This does not preclude other members of the team from being carried through Observed Sections, provided that they are properly seated and are only carried for as far as is necessary, and that the vehicle is stationary when they mount or dismount.

52.3.3. Seat belts need not be worn.

52.3.4. Any team vehicle that cannot maintain unassisted forward motion in the direction of the course must be recovered by other members of the team by pushing, towing or winching.

52.4.1. *All equipment to be used by team vehicles as means of self-recovery, including harness ropes and shackles, must be presented to, and cleared by, the Scrutineer prior to the Start.

52.4.2. This equipment must be carried on team vehicles throughout the Competition.

52.5.1. Before attempting any Observed Section, team vehicles will be brought to rest behind the Start line by Officials and will not proceed until instructed to do so.

52.5.2. *The starting signal will be stated in the SRs.

52.5.3. A team will be considered to have left an Observed Section when all team vehicles have crossed the finishing line.

52.5.4. Where a Competition involves self recovery, failure of all team vehicles to proceed, whether involuntary or otherwise, from the Start line into an Observed Section when instructed to do so will be regarded as a failure in that section.

52.6.1. Any team which fails to complete a section in the stated time will have three minutes added for each vehicle that has not successfully completed the section.

52.6.2. Unless the SRs state otherwise, a penalty of one minute will be added to the team time for each penalty marker touched.

52.6.3. The Official Instructions will state the maximum time allowed for each team to complete each Observed Section.

52.6.4. Results will be determined with reference to the time taken, including penalties, for the team to complete each Observed Section.

52.6.5. Further penalties may be applied if the SRs allow.

Point to Point (22)

53.1. The following regulations are additional to and take precedence over 24 to 35, and 41.

53.1.1. *The SRs will specify whether the event will comprise a set number of points to be visited in the shortest time, or a set amount of time during which the maximum number of points are to be visited. In either case all the team must cross a Finish line.

53.2. *Competitors will be expected to seek and visit points which may be hidden by the natural topography.

The SRs will specify:

53.2.1. If the points are to be visited at random or in a set order.

53.2.2. *If a point comprises a single marker pole with minimum height of 1m, or a gate of poles through which the direction of entry will be marked. Each point visited shall be recorded either by collecting a token or by an Official marking a score card. Tokens and score cards used will be provided by the Organisers.

53.2.3. *The starting signal to be used.

53.2.4. *The method of timing to be used (in accordance with 69).

53.2.5. *The maximum time allowed.

53.2.6. *The number of vehicles in a team.

53.3. Each team must nominate a Captain who will be responsible for carrying the Official score card or tokens for the team and who will produce them to Officials on demand.

53.3.1. In addition to the Driver, vehicles may carry one Passenger or Navigator who must be seated in accordance with the provisions of 41.1.5.

53.3.2. Competitors may be required to dismount at each point visited to record their visit and must fasten safety belts prior to the vehicle moving off again.

53.3.3. No recovery assistance outside that given by a team member is allowed.

53.3.4. Practising is not Permitted.

Cross Country Orienteering (20)

54.1. The following regulations are additional to and take precedence over paragraphs 24 to 35, 27.1, 28.1 and 41 to 43:

54.1.1. Competitors are expected to drive and navigate to specific objectives.

54.1.2. SRs will specify equipment required to meet navigational and route restrictions.

54.1.3. Competitors will be issued with instructions before their due start time.

54.2. No time schedule will be maintained during the event, but the maximum time allowed will be stated in the SRs.

54.3. The method of scoring must be specified in the SRs.

54.4. Objectives must be attempted without the use of winches or other means of assistance.

Challenge Events (23)

55.1. Each vehicle must carry a driver and either a co-driver or navigator.

55.1.1. Drivers and co-drivers must hold a valid RTA licence appropriate to the vehicle and either may drive the vehicle during the event. Navigators, minimum age 16, do not need to hold a valid RTA licence and may not drive during the competition.

55.1.2. Crew members must be accommodated in securely fixed seats and wearing approved seatbelts or harnesses while the vehicle is moving.

55.1.3. There is no compulsion to attempt to reach any point which has been set out.

55.1.4. There is no compulsion to attempt any Special Task. The SRs will specify any penalties which may be applied during the competition, including a maximum speed limit for competing vehicles.

55.1.5. The winner will be the vehicle or team which has attained the highest points score at the end of the competition.

55.1.6. Vehicles must comply with the Challenge Events Technical Regulations.

55.1.7. Winches may be required primarily for the purpose of self recovery.

55.1.8. All equipment to be used by team vehicles as means of self recovery, including ropes, strops and shackles, must be presented to, and passed by, the Scrutineer prior to the start.

55.1.9. The use of winch sails (minimum 1kg dry weight) and gloves is compulsory when winching.

55.1.10. When using winch cable or rope suitable gloves should be worn. Rubber and woollen gloves are not suitable.

Cross Country Driving Tests (23.2)

55.2.1. Drivers must hold a valid full RTA licence (not provisional) for vehicles with more than three wheels and produce a valid Club membership card.

55.2.2. The SRs may Permit entries from Drivers who are 16 or over without a full RTA Licence, provided that their Passenger has experience of Cross Country Trials and holds a full RTA Licence for the vehicle type entered.

55.2.3. The vehicle may only be driven between Driving Tests by a crew member who holds a valid full RTA Licence.

55.2.4. A Passenger may be carried to assist by giving directions when the driver holds a valid full RTA Licence.

55.2.5. The Passenger must occupy the seat alongside the Driver and wear a properly fastened and approved seat belt at all times during the test.

55.2.6. No other Passenger is allowed.

55.2.7. If the Driver holds a valid, full RTA Licence, a Passenger, if carried, must be 12 years or over.

55.2.8. Vehicles must comply with 62.1-62.1.6 and where either crew member is under 16 years of age the vehicle retains the original hardtop or truck cab and the seat belts comply with K2.1.1.

55.2.9. Classes are free, but the class structure must be stated in the SRs.

Driving Test Procedures

55.3.1. Drivers will be considered under Starter's orders when instructed by an Official to proceed to the Start line.

55.3.2. Drivers then failing to proceed may forfeit their run or may be penalised in accordance with Table P.55.5.(a).

55.3.3. A start will only be valid if made under the vehicle's own power.

55.3.4. When a car is required to stop astride a line, the line must be between its front and back axles and all the area of the tyres in contact with the ground must be seen to have crossed the full width of the line.

55.3.5. Similarly, if a car is required to cross a line with all four wheels, all tyre contact area must be seen to be clear of the line.

55.3.6. Timing at completion of a test must be based on the leading wheel (on the same axle) crossing the Finish line.

55.3.7. Penalties will be applied for failure to cross the Finish Line.

55.3.8. In any diagram illustrating a test, the dimensions should be approximate and for guidance only. Indications of the direction of travel of the competing cars when crossing a line, or passing between markers, must be shown unless specified otherwise (ignoring 'shunts' to avoid markers).

55.3.9. A maximum penalty (see Table P.55.5 (c)) shall be applied if a competitor crosses with both leading wheels a marked test line in the wrong direction, out of the prescribed sequence or too many/few times, otherwise competitors may correct their mistakes by returning to the point where they deviated from the test diagram, unless otherwise stated in the SRs.

55.3.10. In changes of direction either lock can be used (unless the test diagram specifically states otherwise).

55.3.11. Clerks of the Course wishing to define direction of travel between markers should include any necessary marked line(s).

55.3.12. In the event of re-run caused by a timing failure, the greater number of penalties incurred in either run will be added to the time taken in assessing the performance on that test.

Marking

55.4.1. Judges must be appointed to each test to adjudicate on:

- (a) False starts
- (b) Crossing/failing to cross marker lines
- (c) Touching markers and not following correct route.

55.4.2. Competitors will be provided with a score card for the Organisers to record times and penalties at the completion of each test run.

55.4.3. Marks will be lost for time taken (if applicable) and for any infringements of the test instructions, such as striking a marker or crossing a boundary line.

Results

55.5.1. To be classified as a finisher, Competitors must complete not less than half of the tests and must hand in their score card to Officials within 15 minutes of all other Competitors completing the final test.

55.5.2. Competitors will start with zero marks.

55.5.3. All Class awards must be calculated on the basis of penalty marks lost, with the Competitor incurring the least penalty points being judged the winner.

55.5.4. In the event of a tie, the Competitor who was first to have the lesser penalty from the start will be adjudged the winner, unless another method of resolving ties is stated in the SRs.

55.5.5. Performance will be assessed as in Table P.55.5, unless the 'Marks Lost' stated are modified by the SRs. See Appendix 1, Table P.55.5.

Technical Regulations

Chassis

56.1. The vehicle must have a minimum wheelbase of 127cm (50in).

Body (including Aerodynamics)

56.2. Unless rear-engined, vehicles must have a bonnet or metal casing of solid flame retardant material covering or surrounding the engine, which is secured by fasteners of adequate strength and with a positive locking action.

56.2.1. Windscreens must be erected unless the event takes place wholly on private property or the SRs state otherwise.

56.2.2. Tailgates may be removed.

56.2.3. Be equipped with mudguards for all wheels which present no sharp edges and cover the complete wheel (flange+rim+tyre) around an arc of 120 degrees. This minimum coverage must:

- (a) be achieved with a continuous surface of rigid material within which ventilation louvres may be fitted. The tyre must not be visible when viewed from above
- (b) extend forward ahead of the axle line
- (c) extend downward behind the wheel.

Seating

56.3. Vehicles must be equipped with two fixed seats for the Driver and Passenger, unless the SRs state otherwise.

56.3.1. The rearmost part of these seats must not be behind the rear wheel axis.

56.3.2. In the case of non production cars, the rearmost part of any additional seat must not be more than 38cm behind the rear wheel axis.

Engine

56.4. Engines must comply with J.5.4.

Suspension

56.5. Vehicles must be fitted with sprung suspension between wheels and chassis, unless originally manufactured otherwise.

56.5.1. Where the top mounting of the shock absorber, whether or not it is fitted with a coil spring, is mounted directly to a main member of the roll-cage, a brace must be fitted between the mounting point and the chassis or those members of the vehicle frame acting as the chassis.

56.5.2. It is prohibited to mount the shock absorber by drilling and/or welding a stud or bolt directly to the roll cage.

56.5.3. All mountings must be made with reinforcements in material at least the same thickness as the roll cage wall thickness.

56.5.4. The recommended mounting is shown in Appendix 1, drawing number 56.5.

Wheels

56.6. Vehicles may not be fitted with duplicated driving wheels unless Permitted by the SRs. The SRs may permit the use of TUV Approved hub adapters/wheel spacers up to a maximum of 30mm in depth.

Tyres

56.7. Tyres must be compatible with the wheels and be acceptable to the Organiser, unless a particular type and size of tyre is specified in the SRs.

56.7.1. Vehicles should carry a securely fastened spare wheel and tyre capable of replacing any one of the wheels in use on the vehicle, unless stated otherwise in the SRs.

56.7.2. Vehicles can have more than four wheels and tyres, but they must be compatible.

56.7.3. All tyres must have at least the minimum legal tread depth on all tyres.

56.7.4. Competitive Safaris, and Hill Rallies must specify tyre eligibility in the SRs. Tyres will be classified as All Terrain, Mud Terrain or Extreme and will be judged against the AT and MT patterns leading manufacturers, including BFG and General Tire.

Transmission

56.8. Vehicles must be equipped with an operable reverse gear and a non-torque biasing differential in full and free operation between the driving wheels, unless:

56.8.1. A differential was not fitted by the manufacturer.

56.8.2. The SRs specify otherwise.

56.9. Vehicles may use all wheel drive (unless the SRs specify otherwise) and may have traction afforded by wheels, track, marine propellers or any combination of these.

Electrical Systems

56.10. Vehicles must not be equipped with more than two auxiliary lights, which must be located in accordance with legal requirements, except where the event takes place wholly on private property.

Silencing

56.11. Vehicles must comply with the silencing levels in J.5.17 but the following parts of J remain unmodified by this section: Brakes, Steering, Cooling, Oil Systems, Fuel Systems, Weight/Ballast, Exhausts.

Safety

Competitive Safari, Point to Point and Hill Rally

56.12. There are three classifications of vehicle design which, whilst requiring the same principles of roll-cage design, may employ different mounting methods.

56.13. Monocoque vehicles: These are of unitary construction employing an integral chassis structure.

56.13.1. They must mount their roll-cages in accordance with K.1.3.2, may fit a diagonal as K Appendix 2, drawings 50 and 51 and must fit longitudinal door bars complying with K.1.3.5(b) (side sections K Appendix 2 Drawing number 9).

56.13.2. A centre roof bar must be installed either diagonally or, evenly spaced in line with the exterior longitudinal bars, as shown in K Appendix 2, drawing 53. If more than one centre bar is fitted, the bars must be evenly spaced. Double crossed roof bars, to the minimum specification for optional members, are strongly recommended, as shown in K Appendix 2, drawing 10.

56.13.3. It is recommended that a horizontal bar be incorporated in the front hoop, located approximately in line with the base of the windscreen, which may be bolted or welded to the front hoop members and shall comply with the specifications for an optional member (57.1).

56.14. Vehicles with chassis: These employ a separate chassis structure from the body or superstructure.

56.14.1. They must mount their roll-cage directly to the chassis in accordance with K Appendix 2, drawing 33, following the principles of K.1.3.2.

56.14.2. Exceptionally where the body contains a superstructure of internal steel pressings including the floor and the roll-cage is MSA/Motorsport UK/FIA certified it is permitted to install the roll-cage in accordance with 56.13.

56.14.3. Where it is necessary to weld additional chassis outriggers on which to mount the roll-cage, these must be of at least 75x50mm box section steel, and not less than 3mm thick.

56.14.4. Alternatively the main hoop may be constructed as in K Appendix 2, drawing 38, allowing mounting to the main chassis rails, or as in K Appendix 2, drawings 50 and 51 where a beam is welded across the chassis rails. This beam must comply with 55.14.3.

56.14.5. Where the roll-cage passes through the superstructure's floor panels, two alternative methods may be employed:

- (a) Either oversize holes allowing uninterrupted passage of the tubes to the chassis placed so as to allow for the movement of the superstructure where this is rubber mounted to the chassis, or
- (b) Or spreader plates complying with K.1.2.2 may be used to sandwich the floor where the cage structure is continued through the floor pan to the chassis and mounted as in K Appendix 2, drawing 33.

56.14.6. The backstays in short wheelbase vehicles may have to be mounted aft of the rear suspension mountings to the chassis in order to comply with K.1.3.2.

56.14.7. K Appendix 2, drawings 52, 53, and 57 show the installation for an external front cage to an internally mounted rear roll bar and backstays showing the method for attachment through the vehicle's roof skin. This installation may only be used where the body is rigidly mounted to the chassis.

56.14.8. The backstays where mounted directly to the chassis must be angled to the main roll hoop as shown in K Appendix 2, drawing 57. Existing vehicles configured with the backstays mounted in line with the main chassis members as shown in K Appendix 2, drawing 57 are permitted.

56.14.9. The longitudinal bars connecting the front to rear roll bars should be straight, or where a manufacturer's truck cab or hard top is fitted the bars may follow the contours of the roof.

56.14.10. A centre bar must be installed either diagonally or, if evenly spaced in line with the exterior longitudinal bars, as shown in K Appendix 2, drawing 53. If more than one centre bar is fitted, the bars must be evenly spaced. Double crossed roof bars, to the minimum specification for optional members, are strongly recommended, as shown in K Appendix 2, drawing 10.

56.14.11. Where the roll-cage is mounted directly to the chassis, the front hoop may be mounted as shown in K Appendix 2, drawing 54.

56.14.12. Alternatively the front hoop may be mounted directly to a fabricated chassis extension, as shown in K Appendix 2, drawing 55. The chassis extension must be constructed as shown in K Appendix 2, drawing 56.

56.14.13. External front hoops must be fitted with a horizontal bar, approximately in line with the base of the windscreen, of the same material and dimensions as specified for the main members of the ROPS, and which may be bolted or welded to the front hoop. Recommended for vehicles with an internal front hoop where installation is practical.

56.14.14. Must be fitted with sill bars of the same material and specification as the main ROPS or primary chassis members, or box section steel, being a minimum of 40mm x 40mm x 3mm or 50mm x 25mm x 3mm. These may be welded or bolted to the main longitudinal chassis members.

56.15. Spaceframe vehicles: These are constructed entirely from a framework including an integral roll-cage made of tubes and/or box sections. For Safari Plus and all Hill Rallies, those elements comprising the primary chassis components must be of at least the same material and dimensions as the primary ROPS members, or equivalent box section steel.

56.15.1. All these vehicles must comply with Safety Criteria K.1.6.1 and K Appendix 2, drawings 6(a) or 36 and have roll-cages incorporated into the frame of the vehicle.

56.15.2. The roll-cage must be welded and integral to the design.

56.15.3. Where there may be difficulty with rear-engined vehicles in respect of fitting a diagonal brace, braces to K Appendix 2, drawings 34 or 35 may be used.

56.15.4. A centre roof bar being of the same material and dimensions as the main ROPS members must be installed either diagonally or, evenly spaced in line with the exterior longitudinal bars, as shown in K Appendix 2, drawing 53. If more than one centre bar is fitted, the bars must be evenly spaced. Double crossed roof bars are strongly recommended, to the minimum specification for optional members, as shown in K Appendix 2, drawing 10.

56.15.5. It is recommended that a horizontal bar be incorporated in the front hoop, located approximately in line with the base of the windscreen, being of the same material and dimensions as the main ROPS members and which may be bolted or welded to the front hoop members. For Safari Plus and all Hill Rallies this horizontal bar is mandatory.

56.15.6. A sill bar or single longitudinal door bar as shown in K Appendix 2, drawing 9, of the same material and dimensions must be fitted.

All Vehicle Types

57.1. Materials and dimensions must comply with K.1.4.1 or be to EN10255 (BS1387) medium weight, blue band: i.e. 42.30x3.2mm for vehicles up to 1000kg and 48.00x3.2mm for vehicles exceeding 1000kg.

Optional tubular members may be added to K1.4.1. or EN10255 (BS1387) medium weight. 30.00mm x 3.2mm. Materials may not be mixed.

57.1.1. All diameters are outside diameters.

57.1.2. All weights are deemed to be un-laden.

57.1.3. New vehicles which do not comply with the above must be approved in accordance with K.1.5.

57.2.1. All vehicles must comply with K.2.1.2, K.3.1.2 (not plumbed in), K.5, K.6, K.8.

57.3.1. If a windscreen is fitted it must be of either laminated glass or plastic of a minimum thickness of 4mm.

57.3.2. If a plastic windscreen is perforated for viewing purposes, approved goggles or visors must be worn.

57.4.1. Two red warning lights must be fitted, to the specification but not location of K.5.

57.4.2. They must be rearward facing and mounted as high as is practicable within the bodywork confines.

57.4.3. These must be switched on in poor visibility or as instructed by the Clerk of the Course.

57.5.1. A passenger grab rail/handle or strap must be fitted in front of the passenger and must be constructed and installed so as not to compromise the safety of the crew.

57.5.2. The fitting of mud flaps, of a flexible material not less than 5mm thick, behind each road wheel extending to a minimum of 4cm each side of the tyre tread, and a maximum of 10cm above the ground when the vehicle is stationary, is mandatory.

57.5.3. All vehicles must carry a small spill kit complying with J5.20.13.

57.6. Point to Note

Additional to 56-57

57.6.1. The requirement to comply with 57.5.2 may be relaxed by SRs.

57.6.2. SRs may permit vehicles complying with 56.6 and 58.4.

Team Recovery and Timed Trial

58.1. All open or soft top vehicles must comply with Safety Criteria K Appendix 2, drawing 1, or with rear stays to K.1.6.1, K Appendix 2, drawings 53, 50 or 38.

58.1.1. All vehicles with manufacturer's hard top or truck cab are recommended to adopt Safety Criteria K.1.6.1, K Appendix 2, drawing 1.

58.1.2. All vehicles must comply with K.3.1.2 (not plumbed in) and K.6.

58.1.3. Criteria K.2.1.1 and K.8 are recommended.

58.1.4. If a windscreen is fitted it must be of either laminated glass or plastic of a minimum thickness of 4mm.

58.1.5. If a plastic windscreen is perforated for viewing purposes, goggles or visors must be worn.

58.1.6. Wire mesh is recommended to the front and rear of the cab, windscreen and rear window.

Challenge Events

58.2. All open or soft top vehicles must comply with Safety Criteria K Appendix 2, drawing 1, or with rear stays to K.1.6.1, K Appendix 2, drawings 53, 50 or 38.

58.2.1. All vehicles with manufacturer's hard top or truck cab are recommended to adopt Safety Criteria K.1.6.1, K Appendix 2, drawing 1.

58.2.2. All vehicles must comply with K.3.1.2 (not plumbed in) and K.6.

58.2.3. All vehicles must comply with K.2.1.1.

58.2.4. If a windscreen is fitted it must be of either laminated glass or plastic of a minimum thickness of 4mm.

58.2.5. If a plastic windscreen is perforated for viewing purposes, goggles or visors must be worn.

58.2.6. Where a windscreen and/or rear window is not fitted to 58.2.4, a full width wire mesh is mandatory of a 2in maximum square aperture and a minimum 10g weld-mesh and must be securely fitted.

58.2.7. All vehicles must carry a small spill kit complying with J5.20.13.

58.3. Road Legal Challenge Vehicle

Road Legal Challenge Vehicles must fully comply with C&U Regulations in all respects. SRs may not relax this requirement.

58.3.1. Vehicles must comply with 56.2.3.

58.3.2. Vehicles must not be fitted with "Tree Wires" nor carry equipment on the front bumper nor front bodywork.

58.3.3. Any vehicle not complying with the above shall be deemed a Challenge Special.

58.4. Challenge Special

58.4.1. All vehicles must be fitted with a circuit breaker(s) which isolates the battery from all electrical circuits, which simultaneously stops the engine and which is operable by the driver whilst correctly seated. K.8 recommended. Vehicles fitted with electric winches may use a second isolator, operated by the primary circuit breaker either by means of a mechanical linkage or via a control circuit, to ensure that all winches and their control solenoids are isolated on operation of the primary circuit breaker.

58.4.2. Rear and four wheel steering is permitted, unless prohibited by SRs.

58.4.3. Steering provided by hydraulic or other method of operation (i.e. not by a direct mechanical link) is permitted. Hydraulic systems may not exceed an operating pressure of 150bar.

58.4.4. Independently operated front and/or rear brakes are permitted.

58.5. Challenge Winching and Recovery Equipment: All Vehicles

The following equipment safety ratings are minima based upon a single line load. Multiple line rigging and the actual mass of the vehicle may require equipment with a higher safety rating. The following minimum equipment must be carried:

58.5.1. A polyester towing rope, or a tow strap rated to 2 tonnes minimum SWL.

58.5.2. Two shackles, stamped with a minimum WLL of 3.25 tonnes and be CE marked.

58.5.3. Two tree protecting strops, labelled with a minimum WLL of 2 tonnes and be CE marked.

58.5.4. Winch cable/rope must be rated in excess of the maximum rating of the winch.

58.5.5. Any loop at the end of a steel cable must be swaged. Any loop at the end of a synthetic rope must be spliced.

Trials and Orienteering

59.1. The following are recommended;

59.1.1. K Appendix 2, drawing 1.

59.1.2. K.2.1.1.

59.1.3. K.3.1.1.

59.1.4. For Orienteering Events all vehicles must carry a small spill kit complying with J5.20.13.

Miscellaneous – All Events

60.1. The following parts of J remain unmodified by this section: Brakes, Steering, Cooling, Oil Systems, Fuel Systems, Weight/Ballast, Exhausts.

60.1.1. Vehicles must be currently registered and taxed.

60.1.2. With the exception of Promotional Events the SRs may relax the requirement for a vehicle to be currently taxed if the event takes place wholly on private property.

60.1.3. The SRs may waive the requirement to comply with J5.20.6.

60.2.1. Vehicles must also comply with all Statutory Regulations as to Construction and Use, particularly with regard to brakes, lighting, tyres, warning devices, rear view mirrors, silencers, speedometers, wings and windscreen, unless the SRs specify otherwise.

60.2.2. Vehicles must be fitted with a substantial towing point front and rear, painted in a contrasting colour, unless the SRs state otherwise.

60.3.1. Vehicles may be modified from manufacturer's original specifications, providing that the modifications meet vehicle regulations.

60.3.2. Independently operated rear brakes are Permitted.

60.4.1. The use of nylon ropes for recovery purposes is recommended.

60.4.2. Non-stretch ropes are acceptable.

60.4.3. Cables or chains are not recommended.

60.5. Where vehicles are fitted with a compressed air tank the pressure shall not exceed 21bar.

60.5.1. The engine must not produce visible smoke or exhaust emissions during the event, however reasonable emissions, such as an occasional "puff" are tolerated. Any named official of the event is empowered to judge this. If the competitor is unable to affect a solution during the event they shall be disqualified from the competition.

60.6. Sports Utility Task Vehicle. A Sport UTV is a two seater all terrain vehicle on general catalogued sale, of which 100 vehicles are produced in a 12 consecutive month period, of less than 1800cc corrected capacity and weighing less than 700 kg.

60.7. Rearward vision whilst properly seated within the confines of the vehicle's bodywork or ROPS must be possible. Vehicles with solid rear bulkheads or an obstructed view along the centreline of the longitudinal axis must be fitted with either external rear view mirrors or a reversing camera. Mirrors and/or cameras must be operational during competition.

Competitive Safaris

61. Classes in Competitive Safaris are free, but must be stated in the SRs.

Tyro Trials

62.1. Tyro Trials allow all standard production 4x4 vehicles with petrol or diesel engines (including military variants of civilian models) mass-produced by a motor manufacturer and generally available for normal retail sale, or available via a network of dealers, whether designed principally for the transportation of passengers, commercial use or dual purpose.

62.1.1. Saloon cars and cars derived commercial vehicles are prohibited.

62.1.2. Vehicles must be currently registered and taxed.

62.1.3. Where appropriate the vehicle must have a valid MOT Certificate where appropriate.

62.1.4. Front seats may be replaced but rear seats, and the original number of seats when the vehicle was manufactured, must be retained.

62.1.5. Bumpers must be retained in their original position.

62.1.6. Safety improvements may be added to the vehicle.

Junior Trials Vehicles

Chassis and Body

63.1. The chassis and bodywork in Junior Trials vehicles must be standard, except where modified to comply with these Regulations, and must be that from a proprietary machine.

63.1.1. J5.3 does not apply in respect of the seat cushion being below the adjacent body.

63.1.2. 56.1 does not apply.

Engine

63.2. Vehicles must be fitted with a four-stroke petrol or diesel vertical crankshaft engine of the industrial and commercial restricted type, designed for use on a Ride on Mower or Lawn/Garden Tractor.

63.2.1. The engine must be fitted in its original location and retain its governor or restrictor, which may not be modified or removed.

63.2.2. The engine must be fitted with an air filter, the type and location of which is free.

63.2.3. The engine must be fitted with an effective silencer.

63.2.4. The silencer and exhaust manifold are free as to type and location, but must be fitted with shields where located outside of the bodywork or chassis.

Transmission

63.3. A manual, constant mesh transmission must be fitted, of the type originally fitted to the vehicle.

63.3.1. Transmissions of an alternative make or model may be fitted.

63.3.2. The Driver must be protected from all drive belts/chains.

63.3.3. Vehicles must not be fitted with a locked, locking or torque-biasing differential.

Wheels and Tyres

63.4. Wheels and tyres are free.

Brakes

63.5. Vehicles must have brake systems operating on both rear wheels simultaneously by a single foot pedal which may activate the brakes either mechanically or hydraulically.

63.5.1. The brakes must be capable of locking the wheels when applied at maximum speed.

63.5.2. A mechanical handbrake must be fitted which operates directly on both rear wheels and is capable of holding the vehicle on a 45° longitudinal gradient.

Steering

63.6. The steering system must retain its original location and operation, and must be un-assisted.

63.6.1. Steering system components are free and may be strengthened.

63.6.2. A steering damper may be fitted.

Front Axle

63.7. The location and mounting of the front axle must be standard to the vehicle and no alteration may be made to the chassis or bodywork to increase articulation.

63.7.1. The front axle may be modified or replaced.

63.7.2. Movement of the front axle may be controlled by the addition of springs and/or dampers, or friction materials between the axle and the chassis.

Safety

63.8. A roll-cage (see K Appendix 2, drawing 58) must be fitted comprising a front and rear hoop which extend the full width of the bodywork and which maintain the minimum clearance above the Competitor's helmet when properly seated (K Appendix 2, drawing 31).

63.8.1. Sidebars must be fitted which prevent the Driver's feet from involuntarily leaving the confines of the vehicle.

63.8.2. A rear brace must be fitted to the rear hoop to guide and locate the shoulder straps of the seat belt.

63.8.3. The roll-cage, comprising the front and rear hoops, lateral bars, side bars and rear brace, must comply with K.1.4 or be to BS1387 medium weight, blue band (ie a minimum 42.30x3.2mm external diameter and wall thickness).

63.9. The roll-cage must be:

63.9.1. Bolted to the chassis with 3mm thick spreader plates and a minimum of two 10mm high tensile bolts at 25mm between centres per mounting (K Appendix 2, drawing 13), or

63.9.2. Bolted to outriggers of 3mm wall thickness bolted/welded to the chassis, using 3mm thick saddles and two 10mm high tensile bolts at 25mm between centres per mounting K Appendix 2, drawing 59), or

63.9.3. Welded to outriggers of 3mm wall thickness bolted/welded to the chassis as K Appendix 2, drawing 51.

63.10. Suitable head protection is strongly recommended.

63.10.1. A seat belt to K.2.1.2, 4 point must be fitted.

63.10.2. A circuit breaker to K.8 which is operable by the Driver when properly seated and which is clearly marked must be fitted.

63.10.3. The battery must be securely mounted and fitted in a sealed container or under the bonnet.

63.10.4. A strong and clearly marked recovery point must be fitted to the rear of the vehicle.

63.10.5. The seat must be rigidly located and designed to securely locate the Driver up to and including the shoulders.

63.10.6. A head restraint must be fitted where not integral to the seat (K.13).

63.10.7. The fuel tank must be located under the bonnet and comply with K.14.1.2.

Miscellaneous

63.11. A front bumper or bush guard must be fitted to protect the chassis and bodywork. This may provide location for under chassis protection and must provide a suitable towing point.

63.11.1. Under-vehicle protection skid plates/guards may be fitted to protect the steering, engine and transmission.

63.11.2. Ballast may be added to the vehicle, provided it is securely attached to the chassis or skid plates.

63.11.3. Ballast must be located below the floor line.

PUBLICATIONS, TECHNICAL PAPERS & CLUB EQUIPMENT



Subject to their availability the products and their prices listed below are correct at the time of going to press, but may be changed without further notice.

PUBLICATIONS (VAT zero rated)

Motorsport UK Yearbook	£35.00
Motorsport UK Karting Yearbook	£19.00

CLUB EQUIPMENT (VAT standard rated incl.)

Club Membership cards	200 for £28.00
Signing-On Sheets – Competitors/Officials	FOC available on website
Signing-On Sheets – Media	FOC available on website
“Prohibited Area” rigid PVC warning signs	per pack of 5 £60.00
“Motor Sports Can Be Dangerous” rigid PVC warning sign	per pack of 5 £60.00

COMPETITORS EQUIPMENT (VAT standard rated incl.)

Motorsport UK Helmet Approval Sticker	£2.60
Motorsport UK FHR Approval Sticker	£2.60

TECHNICAL PAPERS (VAT zero rated, except † = standard rate)

Motorsport UK Rollcage Certificate – Official Copy	†each £30.00
Motorsport UK Historic Rally Vehicle Identity Form Registration	†£100.00
Motorsport UK Vehicle Passport (payable to Inspecting Scrutineer)	£45.00
FIA Historic Technical Passport Application (excluding Registrars Fee) ...	†each £402.00
FIA Current Homologation Papers for any UK car	†each £56.00
FIA Current Homologation Papers for any non UK car	†Price on application
FIA Lapsed Homologation Papers	†each £47.00
FIA Lapsed Homologation Papers for pre-1995 cars	†each £32.00

† Overseas orders are subject to an additional delivery charge

**For the above items, please address order(s) to:
Sales Dept, Motorsport UK, Colnbrook SL3 0HG**

Purchase on-line from www.motorsportuk.org

Appendix 1: Charts and Diagrams

Chart 11.10

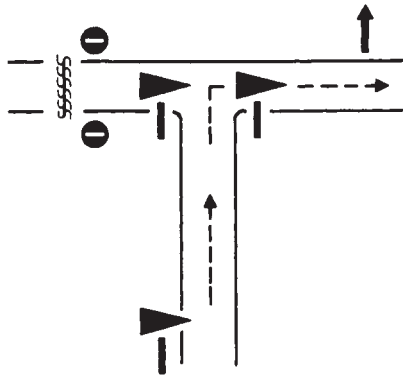
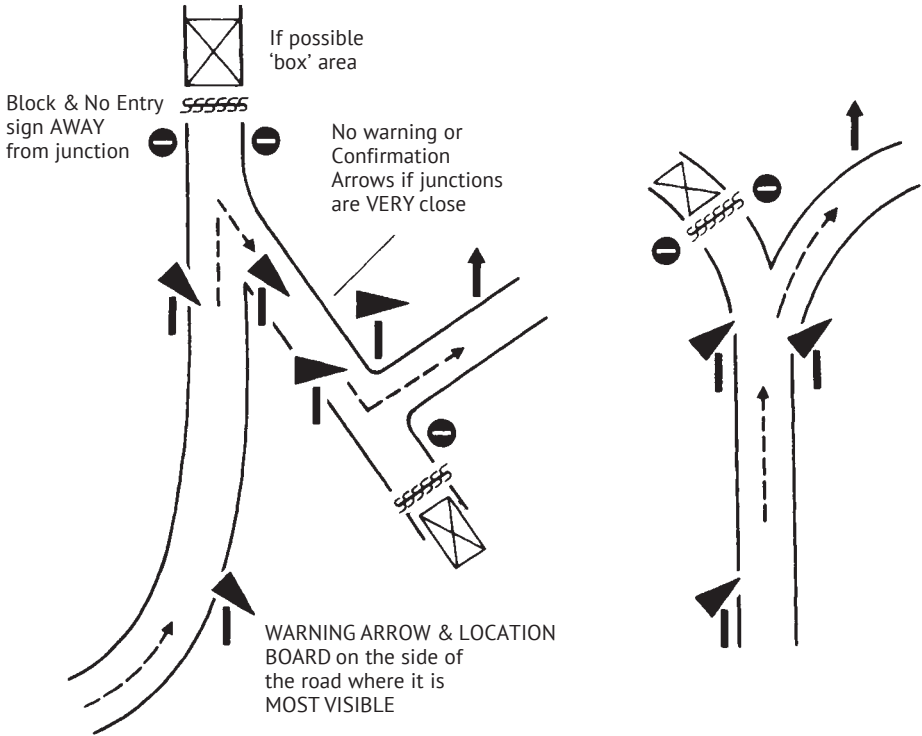

ARROWING SYSTEM

ARROW ANGLES & POSITIONS

- NO ENTRY
- CONFIRMATION ARROW
- PHYSICAL BLOCK

Chart 26(b)















CONTROL TYPE	DISTANCE FROM PREVIOUS SIGN	POSITION	COLOUR	BOARD Black Symbols
PASSAGE CONTROL	n/a	Beginning of Control Area	Yellow background	
	25 metres	At Control Stop	Red background	
	50 metres	End of Control Area	Yellow background	
TIME CONTROL	n/a	Beginning of Control Area	Yellow background	
	25 metres	At Control Stop	Red background	
	50 metres	End of Control Area	Yellow background	
START OF SPECIAL STAGE	n/a	Beginning of Control Area (Stage Arrival)	Yellow background	
	25 metres	Stage Arrival Control	Red background	
	50 - 200 metres	Stage Start	Red background	
FINISH OF SPECIAL STAGE	n/a	Warning of Stage Finish (both sides of track)	Yellow background	
	100 metres	Flying Finish Line (both sides of track)	Red background	
		Countdown boards (evenly spaced between Flying Finish & Stop Line)	Black on white background	
	100 - 300 metres	Stop Line	Red background	
	50 metres	End of Control Area	Yellow	

Chart 30.1.1

ASSESSMENT OF PERFORMANCE – TARGET TIMED CROSS COUNTRY EVENTS

Performance will be assessed as follows, unless modified by the SRs (29.1)

	Road Sections	Special Stages
(a) Not reporting at a control		Retired
(b) Not reporting at or providing proof of visiting a check	30 mins	
(c) Not complying with a requirement of the Road Book or Route Card including visiting a control more than once	30 mins	Stage Target
(d) Not complying with a reasonable instruction by an Official provided warning is given that a penalty will be applied	15 mins	Stage Target
(e) Not attempting or being ready to attempt a stage when instructed to do so		Stage Target
(f) Not completing a stage		Stage Target
(g) Not performing a stage correctly		Stage Target
(h) Making a false start at a stage		1 min
(i) Taking an incorrect route on a Special Stage		Stage Target
(j) Every second taken to complete a Stage (subject to 31.13)		1/60 min
(k) For each minute under Target Time on a Road Section of Service Area	1 min	
(l) For each minute before or after Due Time at a Main Control (out)	1 min	
(m) Breach of a Statutory requirement concerning the driving of a motor vehicle	30 mins	
(n) Contravening 33.4	30 mins	
(o) Breach of Technical Regulations concerning the use of lights and breaches of the Construction and Use or Lighting of Vehicles Regulations	30 mins	
(p) Excessive vehicle noise, excessive speed or driving likely to bring motor sport into disrepute (2.10 and 27.3)	30 mins	
(q) Damaged or ineffective silencing system	30 mins	
(r) Damage to car (28.1.1)	10 mins	
(s) Receiving assistance contrary to 50.1 or 50.6 or contravening 36.1	30 mins	Stage Target
**†(t) Breach of Regulations 25, 36.2, 28.1.1, 50.3, 50.4, 51		Disqualification
†(u) Breach of Regulation 11.2		Stage Target plus 30 mins
(v) Second offence (m), (n), (o), (p), (q), (s)		Disqualification
(w) Breach of Regulation 50.2, 27.4.3, 49.8		Disqualification

**These penalties may not be decreased by the Supplementary Regulations. The decision on causing excessive noise during an event is left to the discretion of the Judge, Environmental Scrutineer (G.7.8), or Driving Standards Observer (G.10.1) who may refuse permission to proceed at any time. Driving Standards Observers' decisions on imposing a penalty for excessive speed or bringing the sport into disrepute will be penalised according to the SRs. Note also powers contained in 27.4.

†Any road section penalties thus incurred will be applied up to and including disqualification.

Chart 30.1.1

ASSESSMENT OF PERFORMANCE – CROSS COUNTRY EVENTS USING SCHEDULED TIMING

Performance will be assessed in one of the methods listed. The 'Marks Lost' penalties as shown below will apply, *unless modified by the SRs or the SRs specify the Fails system (29.1)*

	Marks Lost	or Fails
(a) Not reporting at a control	30 mins	1
(b) Not reporting at or providing proof of visiting a check	30 mins	1
(c) Not complying with a requirement of the Road Book or Route Card including visiting a control more than once	15 mins	1
(d) Not complying with a reasonable instruction by an Official provided warning is given that a penalty will be applied	15 mins	1
(e) Not attempting or being ready to attempt a stage when instructed to do so	Stage Target	
(f) Not completing a stage	Stage Target	
(g) Not performing a stage correctly including taking the incorrect route	Stage Target	
(h) Making a false start at a stage	1 min	
(i) Every second taken to complete a Stage (subject to 31.13)	1/60 min	
(j) Arriving at a control or check, other than at the end of a non-competitive section before Scheduled time per minute	2 mins	
* (k) Arriving at a control or check after due time – per minute, where timing is to whole minutes – per fraction of a minute, where timing is to a fraction of a minute	1 min or fraction	Max. penalty not to exceed that for (a) missing a control
** (l) Early arrival at the end of a non-competitive section	30 mins	1
** (m) Breach of a Statutory requirement concerning the driving of a motor vehicle	30 mins	1
(n) Contravening 33.4	30 mins	1
(o) Breach of Technical Regulations concerning the use of lights and breaches of the Construction and Use or Lighting of Vehicles Regulations	30 mins	1
(p) Excessive vehicle noise, excessive speed or driving likely to bring motor sport into disrepute (2.10 and 27.3)	30 mins	1
(q) Damaged or ineffective silencing system	30 mins	1
(r) Damage to car (28.1.1)	10 mins	1
(s) Receiving assistance contrary to 50.1 or 50.6 or contravening 36.1	30 mins	1
** (t) Breach of Regulations 25, 28.1.1, 36.2, 50.3, 50.4, 51	Disqualification	
† (u) Breach of Regulation 11.2	Stage max. plus 30 mins	
(v) Second offence (o), (p), (q), (r), (s)	Disqualification	
(w) Breach of Regulation 50.2, 27.4.3, 49.8	Disqualification	

*Except in 'neutral' sections where only a maximum lateness penalty equal to (a) shall be applied.

**These penalties may not be decreased by the Supplementary Regulations. The decision on causing excessive noise during an event is left to the discretion of the Judge, Environmental Scrutineer (G.7.8), or Driving Standards Observer (G.10.1) who may refuse permission to proceed at any time. Driving Standards Observers' decisions on imposing a penalty for excessive speed or bringing the sport into disrepute will be penalised according to the SRs. Note also powers contained in 27.4).

†Any road section penalties thus incurred will be applied up to and including disqualification.

Drawing 5.3

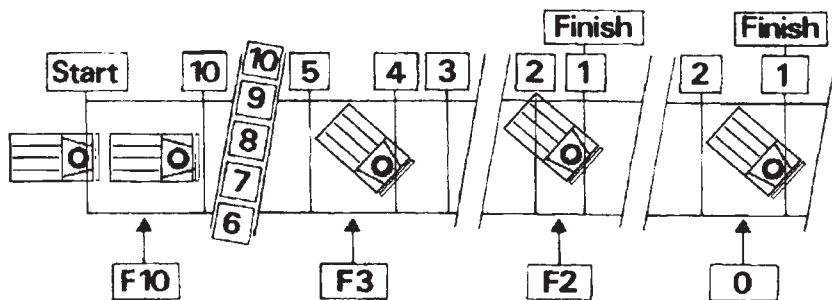

Diagram illustrating the application of 204 to 212. The lower figures preceded by F indicate the correct penalties for a car stopping in the position show.

Drawing 56.5

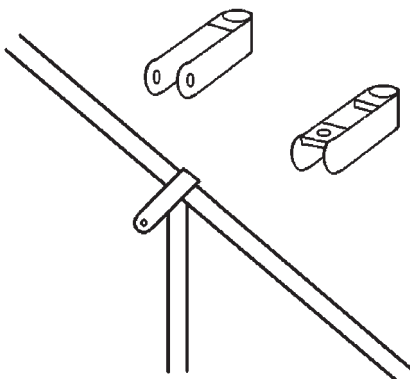

Table P.55.5

CROSS COUNTRY DRIVING TEST PENALTIES

	Marks Lost
(a) Each minute late in reporting at the start or a restart	5*
(b) Not attempting or being ready to attempt a test when instructed to do so	40*
(c) Not performing a test correctly, other than in (d) or (e) or not completing the test or making a false start	40*
(d) Striking any barrier, wall or marker or crossing the boundary of a test (per mistake)	5
(e) Failing to cross or stop at any line or specified position as required in a test (per mistake)	5
(f) Every second (and fraction) taken to complete test	1 fraction
(g) Every second (ignoring fractions) to complete test	1 no fractions