

Specific Regulations for Karting (U)



(U) Karting

Nomenclature and Definitions – Karting

This section of nomenclature and definitions must be read in conjunction with those given in section B of this publication.

Kart. A small four wheel racing vehicle with a rigid frame and no suspension of the wheels. The engine(s) drive the rear wheels only and these rear wheels must be joined by a single piece rear axle with no differential action between them. The Driver will be seated with feet to the fore.

Kart Class. A category within which Kart racing takes place defined by the engine or some other means.

Region. A grouping of individual Kart Clubs as recognised for the time being by Motorsport UK Kart Committee.

Standard Club Meeting. Is that meeting which is run on the Club's monthly set schedule, which forms a round of the Club Championship.

Organisers' Regulations

1.1. Kart Race Meetings may only be organised by clubs registered as Kart Clubs by Motorsport UK.

1.1.1. A Permit for any Kart event is issued at the sole discretion of the Motorsport UK, and is subject to the circuit having a valid Track Licence.

1.1.2. A maximum of one International or Motorsport UK Championship event permit for gearbox and one for non-gearbox karts can be issued on the same weekend.

1.1.3. Organisers must adhere strictly to the Class designations listed in the Motorsport UK Yearbook or Motorsport UK Karting Yearbook and must not in any way modify the title or Classes, or permit the use of unauthorised engines, unless given specific permission by Motorsport UK.

1.1.4. Full details of all approved classes are contained in the current Motorsport UK Karting Yearbook.

1.1.5. Parade/Demonstration

Application may be made for an extension to an Organising Permit to enable a demonstration in line with specific criteria, available upon request from Motorsport UK.

1.1.5.1. Historic Karting. Application may be made to utilise the provisions of the CIK-FIA ClasCIK Karting Guidelines. Motorsport UK may, as detailed below, amend the Guidelines. This does not permit anyone to organise racing events for historic karts under Permit by Motorsport UK.

Motorsport UK may authorise:

- (i) Single-Kart parade
- (ii) Multi-Kart demonstration
- (iii) **Eligible Drivers**

The Driver must reach the following birthday during the calendar year

- 13 years old for a category with a cylinder capacity up to 100cc*
- 16 years old for a category with a cylinder capacity up to 210cc
- 18 years old for any category with a cylinder capacity over 210cc.

* with a restrictor

1.1.5.2. Classic Karting. Motorsport UK may permit an extension to the period specifications of the CIK-FIA ClasCIK Karting Guidelines for Classic Karts 1984 to 1997. Eligible drivers in accordance with 1.1.5.1.(iii).

New Kart Classes

1.2. The acceptance by Motorsport UK of any new Junior or Senior non-gearbox Kart Class is subject to the proposed Class being currently certified under Motorsport UK Kart Class Homologation Regulations, which are available from the Technical Department of Motorsport UK.

1.2.1. *New Junior or Senior non-gearbox Kart Classes will only be homologated at three yearly intervals, the next period commencing 01.01.2021. Applications for new Junior or Senior non-gearbox Kart Class homologations must be made in writing to Motorsport UK by no later than 31st March of the year preceding the next period.*

1.2.2. Exceptionally any CIK recognised and/or homologated Class may be introduced by Motorsport UK at any time.

1.2.3. *From 01.01.2021 only one non-gearbox Kart Class per Kart Category will be permitted from any single manufacturer.*

Specific Types of Kart Race

1.3. An Endurance Kart Race is a Kart Race of a minimum of 60 minutes duration, where the need to refuel and/or make drivers stops, or changes, is an integral part of the race. Drivers must have reached their 16th birthday. A group of licensed drivers may be referred to collectively by their team name without the requirement to hold an Entrants Licence.

There are two types of Endurance Kart events which require different licence grades:

1.3.1. Engines which do not exceed 15hp in total per kart, drivers must hold a minimum of a Kart Clubman Licence.

1.3.2. For engines exceeding 15hp in total per kart, drivers must hold a minimum of a Kart Interclub licence.

Note: Throughout these sections an asterisk(*) indicates a requirement for additional information to be printed in the Supplementary Regulations (SRs). Text shown in *Italics* indicate a Regulation which may be amended in the SRs. Text shown in red indicates a new or amended regulation for 2020.

1.4. A Kart Clubman Event is a Kart event run primarily as entry level Karting. Competitors must hold the minimum of a Kart Clubman Licence.

1.5. Senior Kart Clubman. For 16 year olds and over. Engines may not exceed 17hp in total per Kart.

1.6. Junior Kart Clubman. For 11 to 16 year olds. Engines may not exceed 10hp in total per Kart.

1.7. Bambino Event. Pre-Race training for 6 and 7 year olds, which can only be held on circuits specifically licensed for Bambino. Drivers must hold a Kart Clubman Licence, which they can obtain from their 6th birthday and may continue in Bambino until the 31st December in the year of their 8th birthday. Full details and criteria are contained within the Motorsport UK Karting Yearbook.

1.7.1. A Bambino Race may only be held on circuits specifically licensed for Bambino Racing and may not form part of a Championship other than one run by or on behalf of Motorsport UK.

1.7.1.1. Drivers must hold a Kart Clubman licence, have reached the year of their 7th birthday and have participated in at least 6 Bambino events.

Circuits

2.1. A plan of the track of a scale at least 1:500, together with a Track Data Sheet, must be lodged with Motorsport UK in conjunction with the issue of any Track Licence.

2.1.1. A new application for a Kart Track Licence must be made at least ten weeks before any proposed meeting.

2.1.2. If the Organiser is a new club, its first three meetings after being granted a Track Licence must be restricted to its own Club members subject to Motorsport UK observation.

2.1.3. Track Licences for new Short Circuits must conform to CIK/FIA Regulations and will only be granted after Motorsport UK inspection.

2.2. Licences will be graded as follows:

2.2.1. Suitable for all status meetings up to and including International.

2.2.2. Suitable for all status meetings up to and including National.

2.2.3. Suitable for Interclub meetings only.

2.2.4. If a Long Circuit track incorporates a Short Circuit, the Circuits will be subject to individual grading and Track Licences.

2.2.5. Suitable for Bambino events. A specific endorsement must be detailed on the track licence to permit these events.

2.3. Existing Track Licences will be graded as above by an inspection.

Circuit Categories

2.4. There are five categories of track for Kart racing:

2.4.1. Kart Permanent Tracks with a lap distance of less than 1500m, where the shape can be determined at any time and all protective barriers are permanently in position.

2.4.2. Kart Temporary Tracks with a lap distance less than 1500m, where barriers are not permanently positioned.

2.4.3. Round the Houses Tracks using public roads or passing through residential areas or so classified by Motorsport UK.

2.4.4. Long Circuits Any Kart circuit, other than 2.4.3, exceeding 1500m in lap distance and all licensed Motor Race Circuits.

2.4.5. Indoor Kart Tracks.

Circuit Regulations

2.5. All tracks shall comply with the following conditions:

2.5.1. Minimum width 6m.

2.5.2. Chicanes are not encouraged but when essential they must be approved by Motorsport UK.

2.5.3. The surface must be regular throughout the length of the track, i.e. sealed or unsealed, durable and well graded, and free of holes, rough spots or loose particles.

2.5.4. All obstacles to a Kart leaving the track, such as poles, ditches, etc. must be adequately protected.

2.5.5. The track edges must be marked in a Motorsport UK approved manner.

2.5.6. Half tyres set in the ground are not permitted, and there must be no drop between the edge of the track and the verge.

2.5.7. Any marker must be of a size and weight that will not constitute a hazard.

2.6. If used, tyres should be secured into columns of at least three tyres height, all of the same diameter (Appendix 1, Drawing number 16).

2.6.1. Each column of tyres should be securely banded with non-metallic strapping as shown, bolted as per Motorsport UK specification or secured by any other means approved by Motorsport UK.

2.6.2. Free-standing tyre walls should be formed by securing each column to its neighbour to make up units of at least three columns length.

2.7. Where alternative routes on the same track may be used, those not in use must be clearly marked by bollards or marker boards.

2.7.1. Painted lines on the track surface are not sufficient.

2.8. Any area which may at any time during practice or racing contain people other than members of the organising staff, or Competitors taking part in an event, should be protected from the track and from any area where Karts are in motion by a physical barrier.

2.8.1. This barrier must be permanent with a continuous, smooth, vertical face of at least 1m in height on the track side.

2.8.2. The barrier must be incapable of deflection away from the track if struck by a Kart travelling at the maximum speed likely to be achieved at that portion of the track.

2.8.3. If the barrier is used to contain people in an enclosure, it must be sited not less than 3m from the edge of the track.

2.8.4. On a bend or corner, if the barrier is less than 10m from the edge of the track, there should be a post and rope fence, keeping spectators a further 1m behind the barrier.

2.8.5. Unless otherwise authorised by Motorsport UK, no spectator may be within 3m of the edge of a track on a straight, or within 8m on a bend.

2.8.6. Greater safeguards may be required if an area is considered hazardous, or in the vicinity of Karts travelling at high speeds. In all cases, the maximum possible space must be allowed in head-on situations and through any corner.

2.8.7. Energy absorbing protection of either tyre stacks, straw bales or other Motorsport UK-approved material should be placed in front of the ultimate barrier in head-on situations.

2.8.8. No variation of barriers/enclosures from that specified in the Track Licence will be permitted unless specifically approved by Motorsport UK.

2.8.9. Access to all enclosures and to the track itself should only be by means of controlled entrances.

2.9. Temporary tracks will be subject to Motorsport UK approval and must conform in all ways to the Track Licence issued.

2.10. The maximum number of starters will be calculated as follows, unless otherwise stated on the Track Licence.

<i>Track width</i>	<i>Class</i>	<i>Max starters</i>
Min. width 6m	Non Gearbox	4 per 100m, max 24
	Gearbox	3 per 100m, max 18
	250 Int	3 per 100m, max 18
Min. width 7m	Non Gearbox	5 per 100m, max 34
	Gearbox	4 per 100m, max 30
	250 Int	4 per 100m, max 23

2.10.1. Specific criteria will be determined for endurance races and Bambino events as defined by Motorsport UK.

2.10.2. The grid for a standing start should be laid out so that there is at least 4m between the fronts of each row.

The grid formations will be:

<i>Track width (metres)</i>	<i>Max starters</i>
6 to 8	2 x 2 x 2 max
8 to 9	3 x 2 x 3 max
9 to 12	4 x 3 x 4 max
Over 12	5 x 4 x 5 max

(If approved by Motorsport UK)

2.10.3. Where licensed motor racing circuits are used, spectators must be confined to the normal spectator enclosures.

2.10.4. Safety precautions must be those approved by Motorsport UK for Kart Meetings at that circuit.

2.10.5. Long Circuit races will use slow rolling starts with formations as in 2.10.2.

2.10.6. The number of starters at long circuits will be determined by Motorsport UK.

Equipment

3.1. The following minimum equipment is mandatory for all Kart meetings:

3.1.1. Warning notices, tickets, armbands, etc, as specified in D.31.1.

3.1.2. Flags as detailed in 6.1.4 and Q.15.

3.1.3. Fire extinguishers (minimum 2kg dry powder) with a manufacturer's or agent's certificate issued prior to the season's racing to the effect that they are in working order. As a minimum, one must be available at the start line, two in the paddock in clearly visible positions, and one at each Marshal Post.

3.1.4. Track cleaning equipment comprising two units of:

- One ordinary shovel.
- Two brooms.
- A metal container of 3kg of a suitable cleansing agent for removing oil.

3.1.5. A public address system available to the Clerk of the Course (a hand-held powered megaphone is acceptable as a minimum) for communicating with Competitors

3.1.6. A Starter's Sheet and an Officials' signing-on-sheet in the control of the Secretary of the Meeting

3.1.7. An Official Notice Board, prominently sited in the paddock or at Race Control for all Official communications, grid positions and race results

3.1.8. Certified scales and/or 100kg of certified check weights

3.1.9. A calibrated noise meter, microphone and accessories.

3.1.10. A Small Spill Kit is to be provided in all paddock areas.

3.1.11. At Motor Race Circuits, equipment must be to a similar standard as that required for a car race meeting.

Officials

4.1. Any club organising a Karting event must appoint the Officials listed below and brief them fully prior to the meeting (G.13.1).

4.1.1. All Officials must sign on before commencing their duties.

4.1.2. In carrying out their duties Officials must not expose themselves to any unnecessary hazard. (See Section G.)

Clerk of the Course

4.2. The duties of the Clerk of the Course, who must hold a licence valid for the grade of the meeting, are specified in 21 and G.5.

4.2.1. A Clerk of the Course will normally have only one Deputy at any meeting.

4.2.2. Details of the upgrading procedure for Kart Clerks of the Course are given in Section G.23.

4.2.3. The Clerk of the Course will also be responsible for observing all Competitors at any events where the Stewards of the Meeting are responsible for all judicial duties, and, if satisfied with their competence, signing their licences.

Medical Organisation

4.3. All International Permit and Long Circuits events must have at least one doctor and two ambulances in attendance.

4.3.1. One ambulance must be equipped with portable resuscitation equipment and a crew trained in its use

4.3.2. It is recommended that a fast rescue car is also available for all Long Circuit meetings.

4.4. At all other events a local authority, St John, Red Cross or other approved ambulance, equipped to a suitable standard and including a portable resuscitation unit with crew trained in its use, must be in attendance at all times.

4.4.1. A doctor or Motorsport UK-registered Paramedic (F.7.3.1) must be present throughout practice and racing.

4.4.2. It is recommended that if entries exceed 100, or for Motorsport UK Championship events, there should be two ambulances present, or one ambulance and a fully equipped medical centre (F.6.4).

PUBLICATIONS, TECHNICAL PAPERS & CLUB EQUIPMENT



Subject to their availability the products and their prices listed below are correct at the time of going to press, but may be changed without further notice.

PUBLICATIONS (VAT zero rated)

Motorsport UK Yearbook	£35.00
Motorsport UK Karting Yearbook	£19.00

CLUB EQUIPMENT (VAT standard rated incl.)

Club Membership cards	200 for £28.00
Signing-On Sheets – Competitors/Officials	FOC available on website
Signing-On Sheets – Media	FOC available on website
“Prohibited Area” rigid PVC warning signs	per pack of 5 £60.00
“Motor Sports Can Be Dangerous” rigid PVC warning sign	per pack of 5 £60.00

COMPETITORS EQUIPMENT (VAT standard rated incl.)

Motorsport UK Helmet Approval Sticker	£2.60
Motorsport UK FHR Approval Sticker	£2.60

TECHNICAL PAPERS (VAT zero rated, except † = standard rate)

Motorsport UK Rollcage Certificate – Official Copy	†each £30.00
Motorsport UK Historic Rally Vehicle Identity Form Registration	†£100.00
Motorsport UK Vehicle Passport (payable to Inspecting Scrutineer)	£45.00
FIA Historic Technical Passport Application (excluding Registrars Fee) ...	†each £402.00
FIA Current Homologation Papers for any UK car	†each £56.00
FIA Current Homologation Papers for any non UK car	†Price on application
FIA Lapsed Homologation Papers	†each £47.00
FIA Lapsed Homologation Papers for pre-1995 cars	†each £32.00

† Overseas orders are subject to an additional delivery charge

**For the above items, please address order(s) to:
Sales Dept, Motorsport UK, Colnbrook SL3 0HG**

Purchase on-line from www.motorsportuk.org

4.4.3. If only one ambulance is present and it has to leave the circuit, racing must not continue until it returns, unless alternative suitable transport approved, by the doctor or the chief medical representative, is present and available with sufficient trained staff to man it.

Kart Scrutineer

4.5. The Chief Kart Scrutineer must hold a licence (minimum National grade) valid for the grade of meeting. Licence grades are shown in G.28.

Marshals

4.6. The Clerk of the Course must ensure that responsible persons are appointed as Flag, Track and Paddock Marshals, and that they are fully briefed as to their duties.

4.6.1. All Marshals' posts, as detailed on the Track Plan, must be fully manned and equipped. Trackside posts must be properly protected and Flag Marshals must remain within the confines of that protection.

Flag Marshals

4.6.2. Flag Marshals are responsible for signalling to Competitors and warning them of hazards.

4.6.3. They should not leave their posts to render assistance in the case of an incident.

Course Marshals

4.7. Course Marshals are responsible to the Clerk of the Course for ensuring:

4.7.1. The track surface, markings and protective works are maintained in good order throughout a meeting.

4.7.2. Where alternative routes on circuits exist, they should ensure those not being used are properly indicated

4.7.3. The fire fighting equipment is readily available and correctly sited and that they are familiar with its operation

4.7.4. The track cleaning units are sited at suitable points

4.7.5. Proper supervision of the removal of the track of any Kart which may have stopped on or adjacent to the track

4.7.6. All entrances to the track are manned and that no unauthorised person comes within this area.

4.7.7. If enclosures are not surrounded by fencing, Course Marshals must be stationed at intervals between all enclosures and the track.

Paddock Marshals

4.8. Paddock Marshals must:

4.8.1. Maintain orderly conduct in the paddock and/or pit area. Notify Competitors of their starting positions

4.8.2. Assemble Competitors prior to a race.

4.8.3. Ensure that no competing vehicle goes onto the track until it has been approved by the Scrutineers.

4.8.4. Exclude from the paddock any unauthorised persons.

Secretary of the Meeting

4.9. The Secretary's duties are detailed in G.3.

Stewards

4.10. The organising club is responsible for the appointment of two Event Stewards, whose duties are detailed in 21 and G.2.

4.10.1. The Motorsport UK will also appoint a Steward (whose duties are also detailed in G.2 and 21) who will also be responsible for observing all Competitors (including novices), where the Clerk of the Course is responsible for all judicial duties, and, if satisfied with their competence, signing their licences.

4.10.2. Attention is drawn to G.1.

Lap Scoring and Timing

5.1. Manual lap scoring must be carried out at all meetings. Exceptionally where transponder timing takes place, a working stand-alone camera system under the direct control of the Chief Timekeeper for the purposes of lap scoring may be used.

5.1.1. Where there is no transponder timing the Chief Lap Scorer must be nominated as a Judge of Fact in relation to race finishing order.

5.2. Where timing takes place, there must be a Chief Timekeeper who must hold a licence valid for the grade of meeting detailed in G Table No. 6. Where timing takes place to an accuracy of 0.001 seconds the Chief Timekeeper must be of Kart National grade.

5.3. If using a light beam, timing must be to an accuracy of not less than 0.001 seconds and the equipment must be certified in accordance with G.29.12.

5.3.1. Transponder timing at Short Circuit Kart events must not be to an accuracy of less than 0.01 seconds.

5.3.2. Transponders must be from the Motorsport UK-approved list and used in conjunction with decoders certified in accordance with G.29.12.

5.3.3. The fitment of the transponder must be in accordance with the manufacturer's instructions at a predetermined position on the kart, as detailed in the SRs.

Signals

6.1. Red lights are mandatory for the starting signal.

6.1.1. The National Flag should only be used as a starting signal if the lights fail.

6.1.2. For a rolling start, vehicles start at the moment flag is raised.

6.1.3. For a standing start they start at the moment the flag is dropped.

6.1.4. A Green flag with Yellow chevron indicates a false start (see Section Q for flag signals).

6.2. A Yellow/Black quartered flag may be introduced by the Clerk of the Course at Short Circuit Kart Race meetings.

6.2.1. The flag will be waved and first be displayed at the start/finish line and then will flow around the circuit in both directions, as an adjacent post displays their waved flag.

6.2.2. Upon display of the Yellow/Black quartered flag all Karts must slow down to a steady pace (as on a rolling start) and must line up in order behind the leader who will act as the pace setter.

6.2.3. No overtaking is Permitted.

6.2.4. The field will remain in close formation, at reduced speed, for as long as it takes to clear the obstruction or remove the hazard.

6.2.5. Competitors who fail to slow down sufficiently or who overtake under the Yellow/Black flag may be disqualified or otherwise penalised.

6.2.6. When the Clerk of the Course is satisfied that the problem is resolved, the race will be resumed by the display of a Green Flag at the start/finish line and the simultaneous withdrawal of all Yellow/Black flags around the circuit. Overtaking remains strictly forbidden until having passed the green flag on the start and finish line.

6.3. Yellow flags.

6.3.1. A stationary Yellow flag may be introduced: Danger, slow down sufficiently to ensure that full control of the vehicle can be retained. No overtaking.

6.3.2. Yellow flag – Waved: Great danger. Slow down considerably. Be prepared to suddenly change from the projected racing line, or take other evasive action including stopping if necessary. No overtaking. (This signal may be supplemented by flashing yellow light(s), as an added warning).

Race Procedure

7.1. The Clerk of the Course may permit a change of make of chassis or engine from those nominated on an entry form, provided application is made in writing before the end of scrutineering.

7.1.1. Only a Driver using a scrutineered engine/chassis who has completed a minimum of three laps practice at racing speeds within the Official practice period will be permitted to race.

7.1.2. Only one chassis may be used except when a second chassis is permitted in the SRs.

7.1.3. The maximum number of engines which may be used during a meeting is two, unless specifically varied in the SRs.

7.1.4. Changing the crankcase constitutes a change of engine.

7.1.5. Unless otherwise stated in SR's the Starter shall be deemed as a Judge of Fact in respect of Race Starts.

7.2. The number practising at any time shall not exceed the maximum permitted on the track for a race.

7.2.1. Adequate practice periods must be allotted to all classes, which must include sufficient time for Competitors requiring observation to be seen.

7.2.2. Where possible, novice and experienced Drivers should be allocated separate sessions.

7.2.3. Exceptionally, for Long Circuits, 120% of the number Permitted to race may practice at a time.

7.2.4. At no time may non-gearbox and gearbox Karts practice or race together.

7.2.5. Due regard must be paid to Driver experience and the relative speed of the karts if different classes are on the track at any one time during practice.

7.3. The course or its features or markings may only be changed between the last practice period and the event itself in exceptional circumstances.

7.3.1. Should it be necessary to make any change following the scheduled practice, an additional period of practice must be arranged.

7.4. The starting order in which Karts shall be arranged will be determined by:

7.4.1. Ballot.

7.4.2. Lap times recorded in practice.

7.4.3. Order of receipt of entry.

7.4.4. Finishing order of a preceding race.

7.4.5. As defined in SRs.

7.4.6. With the exception of Kart Tyro Events where the Kart Tyro guidelines apply, in all races where the grid position is determined by 7.4.1, 7.4.3 or 7.4.5, novice Drivers must occupy the rearmost grid positions. Where timed qualifying is used it shall have the same status as a race.

7.5. The Pole position must be on the side of the track that is on the inside of the first corner after the start, or as otherwise defined on the Track Licence.

7.5.1. The start line will be indicated on the track by a painted white line. Optionally (and recommended) tracks may also use the following markings to aid controlled starts (see illustration Drawing 7.5.1):

- (i) Two 2m wide lanes, bordered by white lines will be painted from a point, no more than 100m and no less than 50m leading to the start line.
- (ii) A Yellow Line shall be painted 25m prior to the Start Line. For rolling starts, this Yellow Line will also be indicated by soft cones (one cone on each side of the track).

7.5.2. When the Starter is ready for a race, he must signal by raising a Green Flag. A Marshal will then raise a Green Flag which will be the signal for the Karts to be released on to the circuit. After the Marshal has lowered the Green Flag, the entrance to the track will be closed and no further karts will be allowed to join the track.

7.5.3. Karts will form up in the assembly area and will be started when authorised by the Paddock Official after the Green Flag has been shown. Drivers will be under Starter's Orders from the moment that the Green flag is displayed.

7.5.4. Each track will establish a 'Safety Line'. Any Competitor who, having passed that 'Safety Line', receives assistance from anyone other than a signed-on Official may be disqualified from the results.

7.6. Starts for races shall be as shown below. 'Le Mans' or any starts other than those specified below are forbidden.

7.6.1. Deleted.

7.6.2. Short Circuit events (all classes). A standing start with engines running, or a rolling start.

7.6.3. Long Circuit events. All starts should be slow rolling starts following a formation lap.

7.7. In the case of a rolling start, on display of the Green flag karts will proceed round the course in grid formation at a steady pace to await the starting signal.

7.7.1. The karts may be preceded by an Official pace vehicle.

7.7.2. If there is no pace vehicle the Driver in No.1 position will control the speed.

7.8. When the starter is satisfied that the karts are approaching the start line in correct position and at an acceptable speed, the starting signal will be given by extinguishing the red light (or by raising the National flag should a light failure occur). If a further lap is required the red lights will remain on or the flag will not be raised.

Once the race start has been given drivers can break formation, but should this occur before the lights go out (i.e., drivers leave the corridors, or break formation, with the red lights on (7.5.1)) then a 'false start' penalty will be applied.

7.8.1. False/Jump Start, Standing Start. A false start occurs when a driver under Starter's orders gains an unfair advantage by either:

- (a) being in an incorrect position on the grid, or
- (b) moving forward from his prescribed position.

7.8.2. Breaking formation. When a driver, under Starter's orders, in the case of a rolling start, fails to maintain their corridor, or accelerates early or unevenly.

7.8.2.1. The penalty for the driver concerned shall be the addition of 5 seconds (or 3 places where there is no licensed Timekeeper) to the time taken by him to complete the course. This will not incur penalty points.

7.8.3. Where the optional track markings are used (7.5.1) the Clerk of the Course must make reference to their use in the drivers briefing. When used the start signal will not be given before the Yellow Line. The karts approaching the Start Line must remain in formation, at approximately half race speed (which will be set by the pole sitter) and be driven within the set of two metre lines appropriate to their side of the grid. It will be deemed an offence to accelerate in any way before the Yellow Line or drive outside the marked lines.

7.8.4. Once the signal to start the race has been given, Karts may not stop, intentionally or otherwise, to make repairs or adjustments. They may however drive to the pits, or a designated maintenance area, to undergo repairs or changes.

Stopping of a Race

7.9. The Clerk of the Course (or his designated representative) may decide to stop a race or practice at any time. Should a race be stopped by the display of red flags, the following procedures will apply:

7.9.1. Any race stopped before the leader has completed two laps will be declared null and void.

- (i) The race will be re-run in its entirety, as per 7.10.
- (ii) All available karts will restart from their original grid positions; the grid may be closed up for any missing karts.
- (iii) Front fairings may be reset without penalty on the grid.

7.9.1.1. If it becomes necessary to remove all karts from the track, repairs may be made and all karts that came under starter's orders for the original race will be permitted to start the re-run race from the dummy grid in their original positions.

7.9.2. If 2 or more laps but less than 75% of race distance has been completed by the leader, the Clerk of the Course shall, at his discretion, decide to:

- (a) Abandon the race. In which case the race (result) shall be declared as the order of finishing on the last full lap completed by all karts proceeding under their own power when the red flag was first displayed, followed in classification by non-running karts on a roll back of laps basis and order of stopping.

OR

- (b) Consider the race suspended and run it as a two part race.
 - (i) In this case the Karts will be restarted in a single file, rolling start with no overtaking before the start line

- (ii) After one or more laps under quarter flags (6.2.) the start will be signified by the waving of the green flag.
- (iii) The starting order for the second part of the race shall be the order at the last full lap completed by all karts still proceeding under their own power, when the red flag was first displayed. Any time penalty will be recorded and added to the final result.
- (iv) Drivers "one or more lap(s) down" shall be put in their correct position i.e., behind the drivers on the same lap as the leader.
- (v) The race distance shall be the number of laps required to make up the full race distance.
- (vi) The finishing order of the second part, shall be the finishing order of the race (drivers "one or more lap(s) down" in the first part shall be deemed to have finished the race "one or more lap(s) down" unless they have un-lapped themselves), followed in classification by non-running karts on a roll back of laps basis and order of stopping.
- (vii) If the Judge of Fact reports that the front fairing on one or more karts was no longer in the correct position when the race was suspended, in all situations a time penalty of 5 seconds will be imposed automatically on the driver(s) concerned and added to the final result. This is not susceptible to appeal. Any front fairing which is subject to a Judge of Fact report must be reset on the grid before the race is re-started.

7.9.3. If 75% or more of the race distance has been completed by the leader, the race will be deemed to have ended. The race results shall be declared as the order of finishing on the last full lap completed by all karts still proceeding under their own power, before the red flag was displayed, followed in classification by non-running karts on a roll back of laps basis unless Championship Regulations specify otherwise.

Re-Starting Procedures

7.10. If the race is to be re-run in its entirety, or restarted the following procedure will apply:

7.10.1. While the race is stopped, the whole course will be considered as Parc Ferme and no work may be carried out to any kart (except to reset the front fairing in the correct position under the supervision of the Scrutineers).

- (i) Mechanics will not be allowed on the circuit until permission is given by the Clerk of the Course.
- (ii) Neither the mechanics, nor Incident Marshals already on the circuit, can approach or touch any kart until permission is given.
- (iii) When authorised by the Clerk of the Course, spark plugs may be changed and finger adjustments may be made to the carburettor settings.

7.10.2. If a kart leaves the track during the stoppage,

- (i) It will not be permitted to rejoin the race.
- (ii) Any kart not racing at the time of the incident that caused the race to be stopped, cannot rejoin the re-started race.

- (iii) Karts involved in the incident that gave rise to the stoppage, or who subsequently stopped racing because of the incident prior to the red flag, may only re-join the race if the Clerk of the Course, in consultation with the Chief Scrutineer, is satisfied that a kart is safe to continue without repair, and the Chief Medical Officer is satisfied the Competitor is fit to continue racing. These karts must start at the rear, whether the race is run over the full distance or as a two part race.
- (iv) Those karts that stopped after the incident that gave rise to the stoppage because they were instructed to do so, or because the track was blocked, may join the restarted race in their proper places.

7.10.3. Deleted.

7.1.1. For events on Long Circuits and Round the House Circuits the procedure is detailed in Q5.

Race Finish

8.1. After receiving the end of race signals, all karts must proceed directly to the Parc Fermé without stopping, giving or receiving any object whatsoever and without any assistance (except that of Marshals if necessary).

8.1.1. Any classified kart unable to reach the Parc Fermé by its own means will be placed under the control of Marshals who will supervise the movement of the kart to the Parc Fermé.

8.1.2. Attention is drawn to D18 regarding ineligible entries and Q17.4 regarding results.

8.1.3. Where timing is not authorised, it is prohibited to publish times or speeds in any practice or race result.

8.1.4. Any other publication or display giving this information must clearly be shown and declared as 'Unofficial' and 'For Information Purposes Only'.

Parc Fermé

9.1. The Parc Fermé shall be sufficiently large and secure so that no unauthorised persons can gain access.

9.1.1. Parc Fermé requirements, where appropriate, will be specified in accordance with D25.1.18.

9.1.2. Only authorised Officials may enter the Parc Fermé and no intervention of any kind is allowed there unless authorised by such Officials.

9.1.3. When the Parc Fermé is in use, Parc Fermé regulations will also apply in the area between the finishing line and the Parc Fermé entrance.

Fees for Karting

10.1. See Part 3, Appendix 1.

Championships

11.1. No Championship may take place until a Motorsport UK Championship Permit has been issued.

11.1.1. The Notice of Intent and Regulations must be submitted to Motorsport UK in accordance with the timescales laid down in the guidelines of the Kart Championship Control Panel.

11.1.2. Any Championship for which awards, either race by race or as the result of a series of races, include cash or goods in lieu of cash, or in which a sponsor's name or title is used in connection with the title of the Championship or series, will be considered a Commercial Championship and subject to a Registration Fee, which will be individually assessed.

Competitors' Regulations

12.1. Competitors must report for signing-on and scrutineering at the time specified in the SRs or risk being fined or disqualified.

12.1.1. No kart may be driven in practice or in a race until it has been passed and logged by the Motorsport UK Scrutineer.

12.2. In conjunction with signing-on, the following items must be produced for approval:

12.2.1. Kart Racing Licence of the appropriate grade (14.1).

12.2.2. Club Membership Card (if appropriate) (D.4.3).

12.3. For all events the Clerk of the Course in consultation with the Stewards will designate the race as follows:

12.3.1. DRY – All Competitors shall use dry tyres

12.3.2. OPEN – Competitors have the choice of tyres (i.e. wet or dry)

12.3.3. WET – All Competitors shall use wet tyres.

12.4. A definition of wet tyres appears in 16.9.4.

12.4.1. At no time may a Kart be fitted with a mixture of wet and dry tyres.

12.4.2. Tyres shall only be those defined in the Class regulations.

12.5. Competitors must obey the flag signals detailed in 6 and Q.15.

12.5.1. All karts that take the start by crossing the start line under their own power (7.8) will be classified as a finisher on a roll back of laps basis.

12.5.2. Where the SR's provide, a finisher may have to complete a certain designated percentage of a race in order to be classified as a finisher.

12.5.3. Any Driver leaving the track more than twice, for whatever the reason, may be disqualified from the race (Q.14.4.2 applies).

12.5.4. Where a Driver consistently drives with a wheel off the track or leaves the track, this may be deemed driving in a manner incompatible with general safety and the Driver may be disqualified from the race at the discretion of the Clerk of the Course.

12.5.5. Once a race or practice session has started, karts may only be worked upon in a place of safety.

12.5.6. Refuelling during a race is forbidden, unless Permitted by the SRs.

12.5.7. Any Driver receiving outside assistance, other than by an Official, between coming under starter's orders and the end of the race may be disqualified from the results at the discretion of the Clerk of the Course.

12.5.8. Track regulations in Q.14, as appropriate, apply to kart racing.

12.6. All transmission or communication of data, verbal or electronic, between a moving Kart and the Kart's Entrant or team is only allowed in the following circumstances:

12.6.1. If Officially sanctioned cameras and other recording devices and transponders are fitted as required by the Organisers of a specific meeting.

12.6.2. Voice communication in endurance races where SRs specify the use of relevant equipment, which must be appropriately licensed

12.6.3. A single burst of timing data from the Kart as it passes the receiver.

12.6.4. Where the Competitor has a Motorsport UK approved information system that receives timing data and/or instructions or warnings, which is under the direct control of the Clerk of Course or Chief Timekeeper.

12.7. For Short Circuit Karting only, engines must not be run in the pits or paddock. The Chief Scrutineer may permit a Competitor to start their engine in a designated area only as identified by the Chief Scrutineer.

12.7.1. Deleted.

12.7.2. Deleted.

12.7.3. Deleted.

12.7.4. Deleted.

Clothing

Crash Helmets

13.1. Crash helmets, bearing an MSA/Motorsport UK Approval Sticker, must be worn at all times during training, practice and competition.

13.1.1. The user must ensure that the helmet is to a standard specified in the current Motorsport UK Yearbook, that it fits and is secured properly and that it is in a serviceable condition – see K.10.

13.1.2. Full face helmets are mandatory.

13.1.3. Deleted.

Goggles and Visors (K.11)

13.2. 'Whirley' visors are acceptable when fitted on top of normal visors, but holes must not be cut in normal visors.

Gloves and Suits

13.3. Complete gloves (not mitts or gloves with open backs) and boots (which must cover and protect the ankles) must be worn at all times.

13.3.1. Trailing or loose scarves are not permitted.

13.3.2. For Long Circuit Meetings, all Drivers must wear leather suits or suits approved by Motorsport UK for Long Circuit kart racing.

13.3.3. For Short Circuits, only leather suits, or suits of a recognised CIK homologation standard (as per 13.4.1), are acceptable.

13.3.4. Leather suits must have a minimum thickness of 1.2mm measured at any part of the suit.

13.3.5. All clothing will be securely fastened at wrists, ankle and neck and must be adequate to minimise abrasions.

13.3.6. Drivers may wear two-piece suits providing they are zipped together.

13.3.7. Correctly fitted wet suits, specifically designed for this purpose, may be worn over an approved kart suit.

13.4. Driving suits, helmets, visors etc and all other protective clothing must be presented for inspection by the Scrutineers.

13.4.1. The only acceptable CIK homologated suits are those to standard No. 2001-1 or No. 2013-1, level 1 or 2. Examples of the CIK homologation labels are shown in Appendix 1, Drawing 11.

Kart Licences – See also H22

14.1. Kart Competition Licences (except Kart Clubman licences [1.3]) are issued to Competitors from the age of eight*. There are six grades:

- Interclub
- National
- International C
- International B
- International A.

*Entrant licences will not be issued to persons under 18 years of age.

14.1.1. Retaining and upgrading procedures are given in Section H.19.

14.1.2. A competitor will be considered as a 'Novice' and must use Novice number plates (17.27.4), for Long Circuits Q.11.3. applies, until he has obtained six kart race signatures from Motorsport UK Stewards. (Completion of the ARKS Course (H.8.3) will constitute one of the six signatures.) One of these signatures may have been obtained at a NatSKA meeting held under a Motorsport UK Permit. Thereafter he can continue to compete on an Interclub Licence, or can upgrade to a National Licence in accordance with H.19.2 but he will no longer be considered a novice.

14.1.3. A valid licence, must be produced at signing-on at all events (see H.10). For information on Licence validity, see the chart of Minimum Acceptable Licences in Section H.

14.1.4. For Long Circuit

- (a) the driver may either produce a Kart or Car Race licence specifically endorsed valid for Long Circuit Karting, see the chart of Minimum Acceptable Licences in Section H.
- (b) New competitors will be considered as Novices and must carry Novice plates (Q.11.3) until they have received four signatures from Motorsport UK Stewards for competing successfully on Long Circuits.

14.1.5. For competitors under the age of 18 years, a PG Entrant licence is required, H.26.1.9 applies.

Category Restrictions

15. The Category age and weight breaks are given below. Regulations within the Motorsport UK Karting Yearbook may apply further limitations.

Cadet Category

15.1. Category for 8-12 year-olds.

15.1.1. A Competitor may enter the Cadet Category from their 8th birthday, or the year of their 8th birthday having proof of satisfactorily completed at least 3 Bambino races. Drivers may continue in the Category until 31st December in the year of their 12th birthday.

15.1.2. Having moved into the Motorsport UK Mini or Junior Category, a Competitor may not revert to Cadet.

15.1.3. Deleted.

Mini Category

15.2. Category for 11-14 year-olds.

15.2.1. A Competitor may enter the Mini Category from their 11th birthday, or the year of their 11th birthday with a National licence, and continue until the 31st December of the year of their 14th birthday.

15.2.2. The minimum driver weight and height and the class weight will be defined in the Class Regulations. All will be within the parameters of the current Class Homologation or Re-Homologation Regulations.

15.2.3. Having moved into the Motorsport UK Senior Category, a Competitor may not revert to Motorsport UK Mini or Junior.

15.2.4. A minimum driver weight is required in the Junior Category. This weight will be defined in Class Regulations by applying a kart-to-driver weight ratio as follows:

15.2.4.1. Delete.

15.2.4.2. Delete.

Junior Category

15.3. Category for 13 to 16 year-olds.

15.3.1. A Competitor may enter the Junior Category from the year of their 13th birthday and continue until 31st December in the year of their 16th birthday.

15.3.2. They may not however compete in Gearbox Karts until their 13th birthday (subject to individual Class regulations).

15.3.3. Having moved into the Motorsport UK Senior Category, a Competitor may not revert to Motorsport UK Junior.

15.3.4. It may be possible for a Class to span both Mini and Junior Categories, provided that the height and weight requirements of 15.2.2. are met and that the performance remains within the parameters of the Mini Category.

15.3.5. A minimum driver weight is required in the Junior Category. This weight will be defined in Class Regulations by applying a and will be within the parameters of the current Class Homologation or Re-Homologation Regulations.

Senior Category

15.4. A Novice (14.1.2) Competitor may transfer to the Senior Category from the year of their 16th birthday. Exceptionally the holder of a Kart National A licence may transfer to a Senior non-gearbox Class from their 15th birthday.

15.4.1. A minimum driver weight is required for any driver below the age of 16 competing in a Senior Category, with the exception of International A or B licence holders. This weight is defined in individual Class Regulations.

CIK Classes

15.5. Motorsport UK may authorise, for CIK Classes only, variations to the ages above subject to further limitations, as per Class Regulations.

Bambino

15.6. Pre-race training, in accordance with the current Motorsport UK Bambino Karting Regulations, for 6-8 year olds. A competitor may continue in the class until 31st December of the year of their 8th birthday.

Technical Regulations

16.1. All Karts must comply with these Technical Regulations.

16.1.1. Modification, addition, variation or tuning other than specifically permitted in these Regulations is prohibited. IF IN DOUBT ... DON'T. Anyone requiring clarification or definitions concerning the Technical Content of these Regulations should apply in writing to Motorsport UK.

16.1.2. The approval of a vehicle or component is an indication of the acceptance solely for the purpose of these Regulations, and is not to be taken as a guarantee or warranty as to the standard of its design or manufacture, or its fitness or suitability for any use to which it may be put.

16.1.3. In respect of the following regulations the definition of Magnetic Steel is: Structural steel or structural steel alloy meeting the ISO 4948 classifications and the ISO 4949 designations. Alloy Steels having at least one alloy element the mass content of which is $\geq 5\%$ are forbidden.

Chassis – All Classes

16.2. The Scrutineer must be satisfied that a Kart is safe, is of an adequately strong construction, does not include any temporary components and presents no undue hazard to its Driver or to other Competitors.

16.2.1. In particular, steering, brakes and wheels must be adequate for speeds that are likely to be attained.

16.2.2. Any replacement of original components and fixings must be fit for purpose.

16.3. The chassis frame must be constructed from magnetic steel tubing and be permanently marked with a unique number in an easily accessible position.

16.3.1. Cross-section is free.

16.3.2. It must be of one piece construction, either welded or brazed.

16.3.3. Any form of chassis frame control which includes pivots, dampers or similar devices is prohibited.

16.3.4. No additional holes for lightening or any other purpose (with the exception of those required for seat fixing) may be drilled in the chassis tubes.

16.3.5. Only those holes shown in the manufacturer's homologation, or in a manufacturer's Official replacement parts list, will be allowed.

16.3.6. Independent components fitted to protect the underside of the chassis tubes which may make contact with the ground are prohibited unless they are of a non-metallic type and of a design specifically approved by Motorsport UK. (Note: Engine clamps, battery box clamps and brake disc protectors correctly positioned are exempt).

Dimensions (Excluding Cadet and Bambino Classes)

16.4. Wheelbase.

Non-Gearbox, KZ1 and DD2: Minimum 101cm, maximum 107cm, unless specified in Class Regulations.

Gearbox (except as specified above): Minimum 101cm (250cc and above: 106cm), maximum 127cm.

Track – Minimum two-thirds of the wheelbase.

16.4.1. Overall length – Maximum 182cm without a front and/or rear fairing, 188cm for 210 and 250. Gearbox – 210cm including bodywork for all Gearbox when in Long Circuit trim.

16.4.2. Overall width – All classes, unless specified in Class Regulations Maximum 140cm.

16.5. No part of the kart can protrude outside the quadrilateral formed by the front fairing, rear bumper and outer face of the wheels and tyres, nor be higher than 65cm from the ground (except for a structure solely designed as a head-rest).

16.5.1. Deleted.

16.5.2. The use of titanium or magnesium is prohibited.

Flooring

16.6. There must be a floor made from suitably rigid durable material that stretches only from the central strut of the chassis frame to the front of the chassis frame, unless specified in Class Regulations and for Karts in Long Circuit trim when the floor must be at least from the central strut of the chassis frame to the front of the Kart. The minimum thickness of the floor tray must be 1.4mm for metallic, 1.5mm for composite and 3mm for plastic.

16.6.1. The floor tray must be flat, with any deviation allowed upwards, and not downward.

16.6.2. The floor must be edged on each side with a tube or rim to prevent the Driver's feet from sliding off the floor.

16.6.3. If the floor is perforated on the horizontal surface, with the exception of a hole to access the steering column fixing, the holes must not have a diameter of more than 10mm and they must be apart by four times their diameter, as a minimum.

16.6.4. It is permitted to drill additional holes for the specific purpose of mounting such items as pedal heel stops, ballast, sensors and fuel tank, provided that the holes are restricted to the minimum size and number required to meet the purpose. They must not cause undue weakening of the floor tray at critical points.

16.6.5. It is permitted to use floor trays with decorative holes or slots so long as they are provided by the manufacturer and that the holes are in the raised sector(s) of the tray.

16.6.6. Mechanical fixings with more than three threads protruding on the underside of the floor tray are not permitted.

Suspension (Nomenclature and Definitions)

16.7. Any method of suspension, either by elastomeric material or by pivots, is prohibited.

Wheels

16.8. The wheels must be equipped with pneumatic tyres (with or without tubes) and the front wheels/hubs must be fitted with rolling element bearings.

16.8.1. Wheels which have been cut and welded are prohibited.

16.8.2. The attachment of the wheels to the axles/hubs must incorporate locking pins or self-locking nuts.

16.8.3. The requirement for wheel retaining locking nuts or secondary locking devices is waived for CIK homologated wheels and their associated fixings.

16.8.4. Hubs with a single retaining bolt feature must not protrude beyond the end of the axle, unless designed for that purpose, and must incorporate a retaining device.

16.8.5. Extended hubs with one or two retaining bolts designed to overhang the end of the axle are Permitted.

16.8.6. Any hub with an overall length (excluding wheel studs) of less than 60mm must not overhang the ends of the rear axle.

16.8.7. No form of hub nave plate is Permitted on the wheel.

16.8.8. For Long Circuits, all wheels must be fitted with some form of bead retention, inside and outside. Bead retention as a minimum is defined as a wheel with a minimum of a 0.5mm raised lip on the inner edges of the tyre housing.

16.8.9. For all gearbox karts both rear outer rims must in all cases incorporate additional bead retention comprising three pegs at equidistant positions. Applicable to wet and dry tyres.

Tyres

16.9. When inflated on the wheel rims, tyres must not exceed a maximum external diameter of 35cm. Minimum external diameter must not be less than 22.2cm.

16.9.1. For certain Classes only Permitted tyres may be used as detailed in the Class Regulations.

16.9.2. All tyres designated for a specific Class must be identical in specification to the samples that have been tested and selected. Control tyres may be held by Motorsport UK as a reference in the event of any dispute.

16.9.3. Tyres must be freely available as single units to the open market in the UK so that customers are not forced to buy either complete sets or other equipment in order to purchase a particular tyre.

16.9.4. To qualify as a wet tyre, tyres must be moulded in such a way as to ensure that grooves are created to leave a minimum of 60% and a maximum of 85% of the total surface area as a raised tread pattern. The grooves must have a minimum depth of 2mm at race start.

16.9.5. Hand cutting of all tyres, and remould tyres, are prohibited.

16.9.6. Heating of tyres, by any method, or their treatment by any chemical substance is prohibited. For the avoidance of doubt, no manner of abnormally raising the temperature of the tyres/wheels above the natural ambient temperature is allowed.

16.9.7. The mechanical removal of accumulated rubber debris is permitted.

16.9.8. The interior of the tyre (space between the rim and the internal part of the tyre) must be filled only with air or nitrogen (J.5.9.6).

16.9.9. For all gearbox karts, valve caps must be fitted to all valves at the start of each race or practice session.

Brakes

16.10. Direct drive karts must have effective brakes acting on the rear wheels only, unless specified in Class Regulations.

16.10.1. Karts in the gearbox Classes must have brakes operating on all four wheels, with independent front and rear systems which must be hydraulic. Should one of the systems fail, the other must guarantee braking on two front or rear wheels.

16.10.2. Master cylinders must be fitted in a position safe from impact, at least 150mm behind the front bumper or to the rear of the pedals.

16.10.3. Hydraulic pipes must be securely fitted to the chassis upper sides and should be protected against damage.

16.10.4. All karts must have an effective dual connection between the brake pedal and calliper if mechanical, and between the pedal and master cylinder if hydraulic.

16.10.5. Where there is a dual linkage between master cylinders, the mandatory requirement for a secondary dual connection is waived.

16.10.6. The prime connection may be either solid or cable-operated, with a secondary safety cable set slightly looser to act as a back up in case of failure.

PUBLICATIONS, TECHNICAL PAPERS & CLUB EQUIPMENT



motorsport uk

Subject to their availability the products and their prices listed below are correct at the time of going to press, but may be changed without further notice.

PUBLICATIONS (VAT zero rated)

Motorsport UK Yearbook	£35.00
Motorsport UK Karting Yearbook	£19.00

CLUB EQUIPMENT (VAT standard rated incl.)

Club Membership cards	200 for £28.00
Signing-On Sheets – Competitors/Officials	FOC available on website
Signing-On Sheets – Media	FOC available on website
“Prohibited Area” rigid PVC warning signs	per pack of 5 £60.00
“Motor Sports Can Be Dangerous” rigid PVC warning sign	per pack of 5 £60.00

COMPETITORS EQUIPMENT (VAT standard rated incl.)

Motorsport UK Helmet Approval Sticker	£2.60
Motorsport UK FHR Approval Sticker	£2.60

TECHNICAL PAPERS (VAT zero rated, except † = standard rate)

Motorsport UK Rollcage Certificate – Official Copy	†each £30.00
Motorsport UK Historic Rally Vehicle Identity Form Registration	†£100.00
Motorsport UK Vehicle Passport (payable to Inspecting Scrutineer)	£45.00
FIA Historic Technical Passport Application (excluding Registrars Fee) ...	†each £402.00
FIA Current Homologation Papers for any UK car	†each £56.00
FIA Current Homologation Papers for any non UK car	†Price on application
FIA Lapsed Homologation Papers	†each £47.00
FIA Lapsed Homologation Papers for pre-1995 cars	†each £32.00

† Overseas orders are subject to an additional delivery charge

**For the above items, please address order(s) to:
Sales Dept, Motorsport UK, Colnbrook SL3 0HG**

Purchase on-line from www.motorsportuk.org

16.10.7. Drum brakes are not permitted.

16.10.8. Brake discs must be made from ferrous material.

16.10.9. When a cable is used, a minimum thickness of 1.8mm is mandatory.

16.10.10. An efficient rear brake disc protective pad (in Teflon, Nylon, Delrin, carbon fibre, Kevlar or Rilsan) is mandatory in all categories (except Gearbox Classes unless specified in Class Regulations) if the brake disc protrudes below, or is level with, the main chassis tube nearest to the ground. This protection must be placed laterally in relation to the disc in the longitudinal axis of the chassis or under the disc. It must be located within 120mm of the centreline of the brake disc.

Steering

16.11. The Kart must be controlled by a steering wheel with a continuous rim not incorporating any reflex angles in its basic shape.

16.11.1. The upper and lower one third of the circumference may be straight or of a different radius to the rest of the wheel.

16.11.2. Any device mounted on the steering wheel must not protrude by more than 20mm from the plane forward of the steering wheel (see Diagram 8) and must not have sharp edges.

16.11.3. It is recommended that the minimum diameter for a steering wheel is not less than 300mm across its widest section.

16.11.4. Wheels with flat handgrips are acceptable.

16.11.5. Flexible steering controls, by cable or chain, are prohibited.

16.11.6. All parts of the steering must have a method of attachment offering maximum safety (split pins, self locking nuts or burred bolts).

16.11.7. The fitting of a steering lock is not permitted when the Kart is being driven.

16.11.8. The steering column must have a minimum diameter of 18mm and a minimum wall thickness of 1.8mm. It must be a hollow tube and be constructed from Magnetic Steel.

16.11.9. All karts must have the steering column mounted in such a way that even if the bottom retaining fastening is removed, it cannot pull free from its lower bearing.

Stub Axles

16.12. The use of chromium-plated stub axle assemblies is not permitted for any 250cc Gearbox Classes.

Seating

16.13. It is recommended that the seat be made of a fire retardant material.

16.13.1. It must be rigidly located on the chassis and designed to securely locate the Driver, without movement relative to the chassis when cornering or braking.

16.13.2. It is mandatory that all seats comprise metal or nylon reinforcement at all the anchorage points between the seat supports, any additional seat stays and the seat.

16.13.3. Reinforcements must have a minimum thickness of 1.5mm and a minimum surface area of 13 sq cm, or a minimum diameter of 40mm.

16.13.4. All such supports must be bolted or welded at each end.

Pedals

16.14. Whatever the position of the pedals, they must never protrude forward of the chassis or bumper.

16.14.1. The accelerator must be operated by a pedal equipped with a return spring.

16.14.2. Any device linking the accelerator and brake pedals, such that either of them may be prevented from being independently depressed partially or fully is prohibited.

16.14.3. For Karts in Long Circuit trim the brake pedal and all the parts operating the master cylinders must be made of steel and must be strong enough to withstand the forces applied.

Exhausts

16.15. The exhaust system must discharge behind the Driver and must not exceed a height of 45cm.

16.15.1. The terminal part of the silencer must not cross the quadrilateral formed by the outside of the wheels and the front and rear bumpers.

16.15.2. It must not present a hazard.

16.15.3. The Kart must have protection to prevent any contact between the exhaust system and the Driver when seated in the normal driving position.

16.15.4. Intake and exhaust silencing is mandatory.

16.15.5. Competitors must ensure that engines are prepared and equipped in order to meet or better sound level requirements.

16.15.6. Event Organisers and venue operators may impose more strict levels according to their own environmental requirements. Such additional restrictions must be published in event SRs and be approved by Motorsport UK.

16.15.7. The requirements for sound control Officials (Environmental Scrutineers) are detailed in G.7.8.

Sound Testing

16.16. Effective exhaust and induction muffling is mandatory on all karts so that the sound level regulations contained in 16.15.4 to 16.15.5 and 16.16.6 to 16.16.10 are respected.

16.16.1. The responsibility rests with the Competitor to comply with the sound regulations.

16.16.2. Scrutineers will check all intake and exhaust silencers for professional construction and secure fixing.

16.16.3. Any Competitor losing a silencer during a race will be immediately shown a black flag.

16.16.4. Intake silencers sealed to the carburettor intake, so that all air entering the carburettor passes through the intake silencer, are mandatory for all classes.

16.16.5. Details of specific silencing requirements and of approved silencers are given in the Motorsport UK Karting Yearbook.

16.16.6. Sound testing must be carried out at all kart race meetings using equipment equal to or better than the minimum requirements of G.7.8, which should be calibrated before use.

16.16.7. Tests will be conducted using a microphone suspended over the track above the normal driving line and connected by cable to the sound level meter.

16.16.8. The microphone should be positioned on a straight section of the track at a point where karts are at maximum power.

16.16.9. The measurement position should be selected so that the effects of ambient and reflected sounds are minimised. This position will be shown on the track licence.

16.16.10. Maximum sound levels will be 108 dBA with a microphone set at a height of 1.8m \pm 0.1m, or 105 dBA with a microphone set at a height of 3.6m \pm 0.1m above the track.

Fuel

16.17. Fuel must be Pump Fuel, as defined in Nomenclature and Definitions part (a), plus lubricant, where applicable. CIK compliant Fuel, as defined in Nomenclature and Definitions part (b), may be used if specified in Championship Regulations.

16.17.1. The petrol/lubricant mixture, as well as petrol only, must comply with the specifications in Nomenclature and Definitions.

16.17.2. Electrically powered vehicles are permitted.

16.17.3. Alternative fuels may be permitted subject to Motorsport UK approval.

16.17.4. The fuel tank must be fixed in such a way that neither it nor the fuel pipes, which must be flexible, present any danger of leakage during the competition.

16.17.5. The use of devices fitted to fuel lines, such as 'Powerplus', 'Proplus' or 'Carbonflow', is prohibited.

16.17.6. If plastic is used for the tank, it must be of a type suitable for carrying fuel.

16.17.7. The tank must supply the fuel pump with petrol under normal air pressure only.

16.17.8. Unless otherwise specified the petrol tank must be mounted within the area of the chassis frame.

16.17.9. Where appropriate, the Class Regulations will specify tank capacity.

16.18. For all classes, to enable a fuel test to be conducted, 3 litres of fuel should be present and a minimum of one litre of fuel must be present at the end of each race. The penalty for failure to have the minimum quantity present is disqualification from the results in that race.

16.18.1. This sample of one litre will be sent by Motorsport UK for analysis at a laboratory selected from those on the UKAS list.

16.18.2. In the event that less than 3 litres are available then the competitor forfeits the right to select a sample for their own analysis (D.34 applies).

16.18.3. Competitors must declare the percentage of lubricant used and further must provide when requested a minimum of 0.5 litre of that lubricant.

16.19. Deleted.

Bodywork and Bumpers

17. The following regulations apply unless specifically varied in Class Regulations.

Short Circuit Karts

17.1. All short circuit karts must be fitted with bumpers and bodywork providing front, rear and side protection.

17.1.1. All bodywork fitted to short circuit karts (with the exception of Bambinos, Cadets and Super Cadets) must be CIK Crash-Tested and Homologated, with the sole exception of the rear protection. CIK Crash-Tested and homologated bodywork that expired in 2008 or later, may continue to be used.

17.1.2. CIK bodywork consists of a Front Fairing, Front Panel (Nassau Panel) and Side Pods as well as their homologated bumpers/bars and fixings. All parts must at all times conform to the relevant homologation fiche in every way.

17.1.3. The combination of homologated bodywork elements of different makes or models is authorised, save and except that the two side bodywork elements must be used together as a set. Components from the same element cannot be mixed, i.e. side bars from one homologation cannot be used with side pods from another homologation.

17.1.3.1. Alternative CIK-homologated bumpers, only as detailed on the Motorsport UK published list, may be used in lieu of those homologated with the side pod or front fairing.

17.1.4. No element of bodywork may be used as a fuel tank or for the attachment of ballast.

17.1.5. No alteration of bodywork elements is allowed.

17.1.6. On non-gearbox karts the CIK-homologated detachable front fairing mounting kit (CIK drawing 2c) must be used, unless otherwise specified in Class or Championship regulations.

17.1.7. For Cadet karts in any British or National titled Championship the CIK-homologated detachable front fairing mounting kit (CIK drawing 2c) must be used.

Front Bumper (Drawing 8)

17.2. The front bumper must:

17.2.1. Consist of two steel elements, lower and upper.

17.2.2. Be independent from the attachment of the pedals.

17.2.3. Be attached to the chassis-frame by 4 points.

17.2.4. Have a minimum front overhang of 350mm.

17.3. The lower bar must:

17.3.1. Have a height of 90mm \pm 20mm.

17.3.2. Have two attachment tubes of at least 50mm long, parallel (in both horizontal and vertical planes) to the axis of the chassis. They must be 450mm \pm 5mm apart and centered in relation to the longitudinal axis of the kart. These attachments must be welded to the chassis-frame.

17.3.3. Have a minimum diameter of 20mm (the two corners must have one constant radius of curvature).

17.3.4. Have a straight length of 300mm minimum in relation to the longitudinal axis of the kart.

17.4. The upper bar must:

17.4.1. Have a height of 225mm \pm 25mm from the ground.

17.4.2. Have attachments 550mm \pm 5mm apart and centered in relation to the longitudinal axis of the kart. These attachments must be welded to the chassis frame.

17.4.3. Have a minimum diameter of 16mm (the two corners must have one constant radius of curvature).

17.4.4. Have a straight length of 380mm minimum in relation to the longitudinal axis of the kart.

Front Fairing (Drawing 6)

17.5. The front fairing must:

17.5.1. Under no circumstances be located above the plane through the top of the front wheels.

17.5.2. Not comprise any sharp edges.

17.5.3. Have a maximum gap between the front wheels and the back of the fairing of 180mm (with the wheels in the straight ahead position). 150mm for gearbox karts, unless varied in Class Regulations.

17.5.4. Have a front overhang of 680mm maximum. 650mm for gearbox karts, unless varied in Class Regulations.

17.5.5. Where the CIK-homologated detachable front fairing mounting kit (17.1.6) is mandatory, it must at all times be fitted and maintained in the correct position, in accordance with Drawing 17.5. It is not permitted to reposition, nor attempt to reposition, a front fairing except by stopping in the repairs area (where such a facility is provided) and this may not be done after passing the chequered flag and before release from Parc Fermé.

Front (Nassau) Panel (Drawing 6)

17.6. The front panel must:

17.6.1. Not be located above the horizontal plane through the top of the steering wheel.

17.6.2. Allow a gap of at least 50mm between it and the steering wheel.

17.6.3. Not protrude beyond the front fairing.

17.6.4. Have its lower part solidly attached to the front part of the chassis-frame.

17.6.5. Have its top part solidly attached to the steering column support with one or several independent bar(s).

Rear Bumper

17.7. There is no mandatory requirement for a CIK Crash-Tested and Homologated rear protection system for National events.

17.7.1. For all classes except 210 National, 250 National and pre-2011 Cadet chassis a CIK Crash-tested and Homologated rear protection system in accordance with the CIK regulations may be used in lieu of a rear bumper.

17.7.2. For all Gearbox Classes where a CIK Crash-Tested and Homologated rear protection system is not used, a rear bumper to Gearbox rear bumper regulations (17.13) must be used.

17.8. The rear bumper must:

17.8.1. Be constructed from magnetic steel tubing with minimum outside diameter of 18mm and a minimum wall thickness of 1.4mm.

17.8.2. Consist of a minimum of a single horizontal tube, with outer extensions forming a closed loop, with two link tubes to the chassis anchorage points (as per Drawing 5, Diagram 1) at least 450mm apart at any point. The radius of the outer extension is free but it should not be less than 2½ times the tube outside diameter.

17.8.3. Have its tube and uppermost extension element between 160mm and 200mm above the ground in dry configuration.

17.8.4. Have its upper tube and extension loops made from a single piece of tubing.

17.8.5. In side view, have a rearward rake of between 20 and 45 degrees to the vertical (see Drawing 5, Diagram 3).

17.8.6. Have an overall width not exceeding the rear width of the kart at any time (measured to the outside of the rear wheels or tyres, whichever is the greater).

17.8.7. Cover at least 50% of each rear wheel/tyre at all times.

17.8.8. Have any attachment fasteners made of high tensile steel.

17.8.9. Have any studs with more than 3 threads protruding from the rear of the kart covered with appropriate nuts, caps or suitable protective cover.

Side Bumpers (Drawing 8)

17.9. The side bumpers must:

17.9.1. Be attached to the chassis-frame by 2 points, which must be 500mm ± 5mm apart. These two attachment tubes must be at least 50mm long, parallel (in both horizontal and vertical planes) to the axis of the chassis.

17.9.2. Have their upper bar at a minimum height of 160mm above the ground.

17.9.3. The side bumpers may be shortened and re-drilled in order to reduce the width of the kart; no other modifications are permitted to the homologated side bumpers.

Side Pods (Drawing 6)

17.10. The side pods must:

17.10.1. Under no circumstances be located either above the plane through the top of the front and rear tyres or beyond the plane through the external part of the front and rear wheels (with the front wheels in the straight ahead position). In the case of a "Wet Race" side pods may not be located outside the plane passing through the outer edge of the rear wheels.

17.10.2. Not have the outermost point of the external face located inside the vertical plane through the two external edges of the wheels (with the front wheels in the straight ahead position) by more than 40mm.

17.10.3. Have a ground clearance of 25mm minimum and 60mm maximum.

17.10.4. Have uniform and smooth surfaces that must not comprise holes or cuttings other than those necessary for their attachment.

17.10.5. Have a maximum gap between the front of the side pods and the front wheels of 150mm.

17.10.6. Have a maximum gap between the back of the side pods and the rear wheels of 60mm.

17.10.7. Not overlap the chassis-frame seen from underneath.

17.10.8. Be solidly attached to the side bumpers.

Gearbox Kart Bumpers

17.11. All gearbox karts in the 125 Open, 250 National and 210 National classes, unless specified in class regulations, must be fitted with bumpers/bodywork providing front, rear and side protection.

17.11.1. Rear bumper measurements will be taken as follows: For the upper element, the measurement will be taken to the top of tube.

For the lower element it will be measured to the top of the tube and then the diameter of that tube subtracted, the result being the official measurement of height.

Where a gap is specified, this will be measured between the bottom of the upper element and the top of the lower element. All measurements to be taken with the kart in dry condition.

Front Bumper

17.12. The front bumper must:

17.12.1. Consist of at least 2 steel elements. A steel upper bar mounted in parallel above a steel lower bar, with a minimum diameter of 18mm and a minimum wall thickness of 1.5mm, both bars being connected with 2 vertical tubes and welded to the upper rail as a minimum, and presenting a vertical flat face.

17.12.2. Allow the attachment of the front fairing whenever a mandatory requirement.

17.12.3. Be attached to the chassis frame by 4 points.

17.12.4. Have a front overhang of maximum 350mm.

17.12.5. Have the lower bar straight and with a width of 150mm minimum in relation to the longitudinal axis of the kart.

17.12.6. Have the attachments of the lower bar parallel (in both horizontal and vertical planes) to the axis of the chassis; they must be 155mm minimum apart, but are recommended to be a minimum of 220mm apart as mandated by CIK Superkart regulations, and centred in relation to the longitudinal axis of the kart at a height of 60mm \pm 20mm from the ground.

17.12.7. Have the upper bar straight and with a width of 250mm minimum in relation to the longitudinal axis of the kart.

17.12.8. Have the upper bar 170mm minimum and 220mm maximum above the ground.

17.12.9. Have the upper bar attachments 500mm \pm 50mm apart and centred in relation to the longitudinal axis of the kart.

17.12.10. Have the attachments of the upper bar and the lower bar welded to the chassis frame.

17.12.11. At no time have its upper element exceeding the height of the foot pedals, with the pedals in the relaxed position.

Rear Bumper

17.13. The rear bumper must:

17.3.1. Be constructed of magnetic steel tubing with a minimum outside diameter of 18mm and a minimum wall thickness of 1.5mm.

17.13.2. Consist of a minimum of two horizontal and parallel tubes, with outer extensions forming a closed loop with a minimum radius of 2½ times the tube outside diameter, with two vertical link tubes to the chassis anchorage points (as per Drawing 5, Diagram 2).

17.13.2.1. The vertical gap between any two horizontal elements must not exceed 95mm. Should that maximum dimension be exceeded there must be at least one element – minimum outside diameter of 18mm and minimum wall thickness of 1.5mm – fitted approximately centrally and vertically seen from the rear, either permanently fixed or clamped between these horizontal elements.

17.13.3. Have its upper tube and uppermost extension element between 220mm and 280mm above the ground and be a minimum of 1100mm in length, and a maximum of the overall kart width.

17.13.4. Have its upper tube and extension loops made of a single piece of tubing.

17.13.5. Have its lower tube fixed horizontally between the main uprights or the end of the chassis main tubes, between 40mm and 90mm above the ground in dry configuration, be straight and a minimum of 600mm in length. If the kart is fitted with a rear diffuser with a minimum of 4 vertical strakes, not more than 20mm from the bumper, the minimum height of the lower element must be between 75mm and 165mm.

Alternatively, and for Long Circuit only, the lower tube must be between 100mm and 140mm above the ground in dry configuration, be straight and a minimum of 600mm in length.

17.13.6. Inside, have a rearward rake of between 0 and 45 degrees to the vertical (Drawing 5, Diagram 3).

17.13.7. In the case where a vertical bumper is fitted, have the extension loops strengthened by triangulated steel braces to the chassis to reduce folding in onto the rear tyre.

17.13.8. Have an overall width not exceeding the rear width of the kart at any time (measured outside the rear wheels or tyres, whichever is the greater).

17.13.9. Cover at least 50% of each rear wheel/tyre at all times.

17.13.10. Have any attachment fasteners made of high tensile steel.

17.13.11. Not be an alternative design/material or an adjustable width bumper, except with specific written approval from Motorsport UK.

17.13.12. Have any studs with more than 3 threads protruding from the rear of the kart covered with appropriate nuts, caps or suitable protective cover.

Side Bumpers

17.14. These side bumpers are mandatory in all configurations whenever CIK crash tested bodywork is not used.

17.15. Side bumpers must:

17.15.1. Be made from magnetic steel tubing with a minimum outside diameter of 18mm and a minimum wall thickness of 1.5mm.

17.15.2. Consist of two bars each side of the kart both bars being connected with 2 tubes and welded together, and presenting a vertical flat face, and they must be attached to the chassis frame by a minimum of 2 points. These 2 attachments must be parallel to the ground and must be a minimum of 450mm apart. Note for CIK Division 1 and 2 Superkarts, the 2 attachments must be perpendicular to the axis of the chassis and must be a minimum of 520mm apart.

17.15.3. Have a clearance between the bars and the tyres not exceeding 100mm (with front wheels in the straight ahead position).

17.15.4. Not extend beyond the plane through the outside of the front and rear tyres, with the front wheels in the straight ahead position (dry configuration).

17.15.5. At all times cover a minimum of 66% of the rear tyres.

17.16. The lower bar must:

17.16.1. Not exceed the height of the top of the rear axle.

17.16.2. Have a minimum straight length of 500mm.

17.16.3. Be 60mm \pm 20mm from the ground.

17.17. The upper bar must:

17.17.1. Deleted.

17.17.2. Be joined to the lower bar at each end and also include two additional uprights.

17.17.3. Have a minimum straight length of 400mm.

17.17.4. Be 200mm ±20mm from the ground.

Gearbox Short Circuit Bodywork

17.18. Gearbox Short Circuit bodywork is defined as including mandatory bodywork to general Short Circuit Kart regulations unless varied in Class regulations.

17.18.1. Lateral bodywork and front fairings must never cut the plane through the top of the front and rear tyres.

17.18.2. Rear vertical wing ends are permitted if class regulations allow but any form of wing or winglets or fully enveloping body panels are not permitted.

17.18.3. Flooring as 16.6 for short circuit karts.

Gearbox Long Circuit Trim

17.19. Gearbox Long Circuit Bodywork trim is defined as any combination of wings (either full width or part width), side pods which are above the plane of the top of the front to rear tyres, or a full width front fairing to 17.23.2.

17.19.1. Wings are not mandatory.

17.19.2. If a front fairing is mandatory it will be specified in Class Regulations.

17.19.3. No part of the bodywork, including wings and end plates, shall be adjustable from the driving seat in racing condition when the kart is in motion.

Long Circuit Bodywork

17.20. Bodywork, bubble shield and wing must:

17.20.1. Be soundly constructed of a non-metallic material.

17.20.2. If plastic be splinter-proof.

17.20.3. Be designed to provide maximum safety for the driver and other competitors both during normal racing and in any accident.

17.20.4. Not present any sharp edges.

17.21. No part of the bodywork, including wings and end plates, shall:

17.21.1. Be higher than 600mm from the ground (except for structures solely designed as head-rests with no possible aerodynamic effect).

17.21.2. Extend beyond the rear bumper.

17.21.3. Be nearer to the ground than the floor tray.

17.21.4. Extend laterally beyond the plane of the front and rear tyres (with the front wheels in the straight ahead position and with the wheels in their outermost position), except in the case of a wet race (see Drawing 7, Diagram 9).

17.21.5. Have a width of more than 1400mm.

17.21.6. Have a gap of less than 25mm between any part of the bodywork and the tyres.

17.22. Should a complete bodywork and bubble-shield be used, the bubble-shield shall be connected to the bodywork by no more than four quick release clips and shall have no other fixing device.

17.22.1. Should the bubble shield be a separate structure, its maximum width shall be 500mm and the maximum width of its fixing frame 250mm.

17.22.2. The bubble-shield must neither be located above the horizontal plane passing through the top of the steering wheel nor be less than 50mm from any part of the steering wheel.

17.22.3. At the bottom the bubble-shield shall end symmetrically 150mm minimum from the pedals in the normal resting position and shall expose (not cover) the feet and the ankles.

Officiel d'Honneur Appointments

The following have accepted the position of Officiel d'Honneur for 2020:

M F L Allison

G H Bailey

W Beattie

I D Bennie

K N Blackburn

G S B Blythe

H T Chapell

T J Hassall

A Dean-Lewis MBE

R McCabe

N S Manser

P J Smith

Dr D B Stevens MBE

J B H Wood

B Wright

17.22.4. In all cases, when the bubble-shield is removed, no part of the bodywork shall cover any part of the Driver seated in the normal position seen from the above.

17.23. The front of the nose of the bodywork must not constitute a sharp angle but must have a minimum radius of 20mm.

17.23.1. Front fairings must be such that it is possible for the front bumper to comply with the requirements.

17.23.2. They must not be wider than the front wheels when in a straight ahead position and the top of the fairing must be above the horizontal plane passing through the top of the front tyres.

17.24. The floor tray shall be of flat construction and must have a curved beading edge.

17.24.1. From 230mm ahead of the rear shaft, the floor tray may have an angle orienting it upwards (extractor). If the latter has one or two side fins, they must not protrude beyond the plane formed by the flat part of the floor tray.

17.24.2. Neither the floor tray nor any other part of the bodywork shall in any way resemble a skirt.

17.24.3. The floor tray shall not extend beyond either front or rear bumpers.

17.24.4. The width of the floor tray shall conform to and not exceed the dimensions of the bodywork including wings and end plates.

17.24.5. It is not allowed to cut lightening holes in the floor tray.

Number Plates

17.25. Number plates must have rounded corners (with diameters 15 to 25mm) and 22cm sides.

17.25.1. Stick-on panels used on an existing surface in lieu of a number plate need not have rounded corners and must be at least 17cm high by 17cm width with a minimum 1cm space on all sides of the numbers.

17.25.2. Number plates or stick-on panels as described above must be displayed in accordance with drawing 17.25. The numbers must be at least 15cm high and 2cm stroke width.

17.25.3. Numbers must be fitted to front, rear and both sides.

17.25.4. Number plates must be securely attached and numbers always legible.

17.26. For Long Circuit events, number plates must be carried front, rear and on the side facing the Timekeeper's box.

17.26.1. The plates must be square with sides of minimum 25cm.

17.26.2. The numbers must be minimum 20cm high with a minimum stroke of 3cm.

17.26.3. The plates must be fixed so as not to bend or otherwise change their attitude in the airflow.

17.26.4. The front and side number plates may be made of fibre glass (polyester).

17.27. No Club may alter the requirements concerning the numbering of Karts.

17.27.1. The plates must be in opaque flexible plastic, fixed in such a way that they are not deflected by the airflow.

17.27.2. The plates must be solid or be attached to a solid backing and contain no holes other than those required for fixing.

17.27.3. The numbers must be of the 'Classic' type as shown below and represented with an Arial type font:

1-2-3-4-5-6-7-8-9-0.

17.27.4. Novice number plates will be black with either white or yellow numbers.

17.28. Motorsport UK reserves the right to approve non-standard race numbers such as Grand Prix Winner – GP and 0 (zero), and also race numbers 1-10 (one to ten). No other non-standard numbers or numbers 1-10' are permitted.

17.28.1. Those awarded their respective "number" (one to ten) or non-standard plate may use it for the following year should they continue to race in the same Class and in the same type of event (Short Circuit Gearbox one to ten may not use their numbers for Long Circuit events or vice-versa).

As soon as Championship results are declared final the previous seasons plates may no longer be used and the new Championship winners will be the only drivers allowed to use such numbers.

Weight

17.29. Subject to 15, clubs may run classes to heavier weight limits (if Motorsport UK approval is given by the issue of a Kart Technical Exception (KTE)), but may not reduce the weight limits.

17.29.1. If it is necessary to use ballast in order to achieve a minimum weight no installation of ballast, be it a single unit or combination of units, may exceed 5kgs each and each such installation must be attached by at least two mechanical fixings.

17.29.2. More than one installation of ballast may be used provided that each is attached in accordance with 17.29.1.

17.29.3. No solid object (excluding jewellery/dog tags) may be carried on the Driver's person.

17.29.4. Plugs and plug spanner may be carried on the Kart in a suitable receptacle, secured to the kart in a manner acceptable to the Scrutineer.

17.29.5. After a Kart and Driver have competed in a heat or race, it is not permissible to alter the weight of the Kart or Driver in any way before being weighed.

17.29.6. For classes that include a minimum driver weight only mandatory items of Personal Protective Equipment (PPE), as required by 13.1-13.3, are to be included when the Driver is weighed.

Rear Lights on Long Circuit Gearbox Karts

17.30. A rear-facing high intensity lamp must be fitted.

17.30.1. It will be permanently illuminated when wet tyres are fitted to the kart or a race is designated as a wet race, or when instructed to do so by the Clerk of the Course.

17.30.2. Only lamps having a high intensity, polarised light source and homologated with the MSA/ Motorsport UK/FIA will be permitted.

17.30.3. The lens must have a minimum surface area of 28 sq cm and the illumination must be visible from a point 45° either side of the centre line.

17.30.4. The lamp unit must be mounted securely and centrally on the Kart, forward of the rear bumper and the whole illuminated area of the light is to be positioned in the area shown in drawing 17.30, in wet or dry configuration.

17.30.5. The light must be able to be switched on by the driver when seated in the normal driving position by means of a switch.

17.30.6. Karts with lights not switched on when a race is declared wet will not be let out onto the circuit from the Assembly Area or Pit Lane.

Engines and Transmissions

18.1. The Scrutineer must be satisfied that the engine, transmission, exhaust system and all associated parts are installed in a workmanlike manner and will perform safely and present no undue hazard to the Driver or other Competitors.

18.1.1. Where hand-throttle systems are fitted to assist push starts, these should be maintained in a clean and fail-safe condition.

Engine

18.2. The engine must be the sole propelling unit of a Kart in running order.

18.2.1. It may be a two or four stroke engine, but both types may not take part in the same race (except Formula Cadet and compatible four stroke Cadet Classes which may be amalgamated).

18.2.2. Other four stroke engines of equivalent performance may be raced with two stroke engined karts in the same race, subject to Motorsport UK authorisation.

18.2.3. Unless the SRs state otherwise, only engines readily available through normal commercial channels may be used.

18.2.4. Forced induction in any form is not permitted.

18.2.5. Power valves are allowed subject to class regulations.

18.2.6. All electronic/microchip methods of operation are forbidden.

18.3. Unless Class Regulations permit, any form of manually operated or variable ignition (advancing or retarding systems) is forbidden.

18.4. Unless Class Regulations permit, the use of programmable electronic engine management systems, which can be varied whilst the kart is in motion, is also forbidden.

18.5. Engines must be fitted with effective radio interference suppressors.

18.5.1. Only sealed, leak proof batteries are permitted.

18.5.2. Proprietary lead acid batteries, sealed for life, properly mounted and protected, are acceptable.

18.5.3. Engine starter batteries where permitted must be fitted to a main chassis rail or within the confines of the main chassis frame and shall be placed on the chassis in an area located to the side of the seat opposite the engine and behind the central strut or alternatively mounted on or behind the seat. If Lithium batteries are used, they must carry the appropriate "EC" and "E" markings.

18.5.4. Terminals and electrical connectors must be covered with insulating material.

18.6. No part of the cooling system is permitted to be located directly in front of the Driver's seat and may not pass over any part of the Driver's body.

18.6.1. All pressurised pipes must be reinforced and a catch tank is recommended on cooling systems with vented caps.

18.6.2. A retaining device is recommended on pressure caps.

18.6.3. The use of inhibiting agents including anti-freeze is permitted.

Transmission

18.7. The transmission is the method of transferring drive from the crankshaft drive sprocket to the back axle sprocket.

18.7.1. For some classes this drive may have a variable ratio gearbox interposed between engine and back axle sprocket.

18.7.2. Direct drive classes must not be fitted with a variable ratio transmission. However, they may be fitted with a clutch if permitted in Class Regulations.

18.7.3. Clutches are recommended for all Cadet and Junior categories, and are mandatory for all new Cadet and Junior UK homologated engines.

18.7.4. Karts competing in the Gearbox Classes must be equipped with a variable ratio transmission providing a minimum of two speeds and must be fitted with a clutch.

18.8. All classes must use axles of magnetic steel material with a maximum external diameter of 50mm.

18.8.1. The axle wall thickness at all points (except in keyway housings) must comply as minimum to the dimensions shown in the table below. Exceptionally axles for use in 210 and 250 National classes with a diameter greater than 40mm must have a minimum wall thickness of 2.9mm. Please also refer to class regulations for any variations.

Motorsport UK House

OPEN

Monday – Thursday
9.30 – 5.30

Friday

9.30 – 5.00

(phone enquiries
10.00 – 5.00 please)

Tel: 01753 765000

Fax: 01753 682938

Licence Section:

Tel: 01753 765050

Fax: 01753 685426

Website:

www.motorsportuk.org

<i>Maximum external diameter</i> (mm)	<i>Minimum thickness</i> (mm)
50	1.9
49	2.0
48	2.0
47	2.1
46	2.2
45	2.3
44	2.4
43	2.5
42	2.6
41	2.8
40	2.9
39	3.1
38	3.2
37	3.4
36	3.6
35	3.8
34	4.0
33	4.2
32	4.4
31	4.7
30	4.9
29	5.2
28	Solid Axle
27	Solid Axle
26	Solid Axle
25	Solid Axle

18.8.2. The drive must always be to the rear wheels only.

18.8.3. Any method may be used provided no differential is incorporated.

18.8.4. All methods of chain oiling and greasing whilst the vehicle is in motion are forbidden, unless specifically permitted in the SRs.

18.8.5. Effective protection must be provided over the top and both sides of the exposed transmission chain (or belt) and sprockets, and extend to at least the lower plane of the rear axle.

18.8.6. Access for the starter is permitted.

18.8.7. Clutches on non-gearbox karts must be covered preferably by metal guards.

18.8.8. Non-gearbox karts must use a 219 pitch chain only.

18.8.9. For Long Circuit all rear axles must be fitted with a circlip – or a similarly effective hub retaining device – on each end of the axle.

Cameras

19.12.6.1 applies. Cameras must be attached securely to the kart and be approved by the Chief Scrutineer and Event Organiser. The weight of the camera (excluding any additional casing, mounting and associated fixing) must not exceed 100gms.

Procedure for the Testing of Tyres (C4.3)

20.1. See D36.

Judicial

21.1. Clubman Short Circuit Kart events: The Clerk of the Course is responsible for all judicial duties, with the exception of meetings as specifically authorised by Motorsport UK for the Stewards of the Meeting to have judicial responsibility

21.1.1. Neither the decision for imposing any penalty nor the penalty itself, during any timed qualifying or heats, is eligible for appeal.

21.1.2. In respect of the final(s), the Stewards of the Meeting may hear a validly lodged appeal where permitted against sporting matters determined by the Clerk of the Course. However there is no right of appeal to the National Court against any sporting decision of the Stewards of the Meeting OR against any eligibility Decision.

21.2. For Interclub and above status short circuit Kart events: The Stewards of the Meeting are responsible for all judicial duties as well as at any Clubman meeting where specific authority has been given by Motorsport UK.

21.2.1. Neither the decision for imposing any penalty nor the penalty itself is eligible for appeal.

21.2.2. Any penalty resulting from a Judge of Fact statement may be imposed directly by the Clerk of the Course.

Drawing number 16

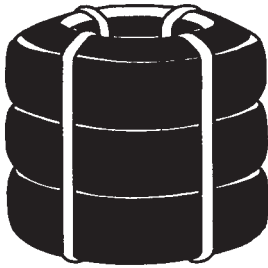

Drawing number 2

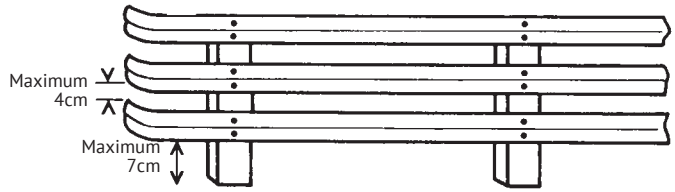

If open type fencing or railing is employed, the gap at the bottom should not be more than 7cm in height, and the gap between the rails not more than 4cm. The support posts must not protrude above the level of the top rail.

Drawing number 10

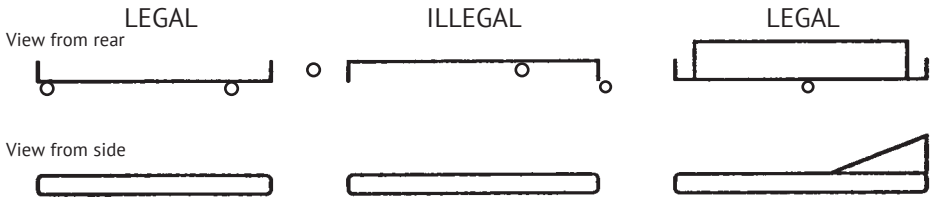

Drawing number 11

Only suits bearing one of the below labels are acceptable as CIK homologated.

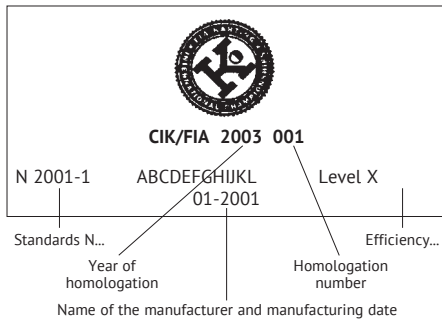

Drawing number 5

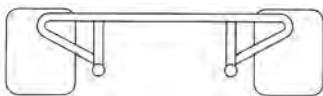

Diagram 1

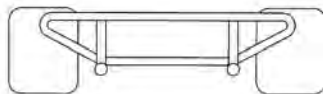

Diagram 2

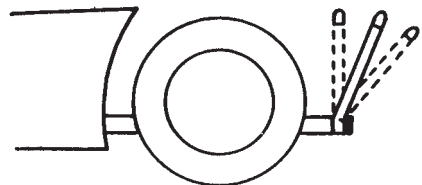
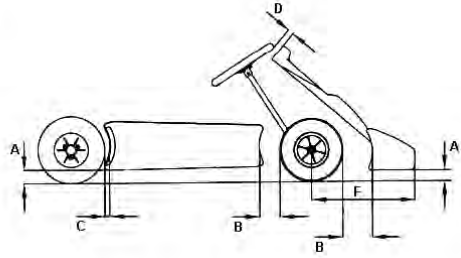
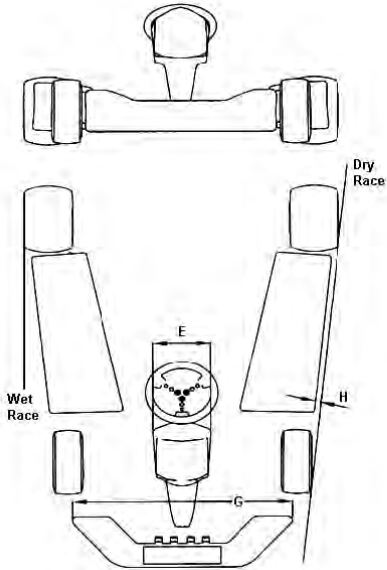

Diagram 3

Drawing number 6



Code Letter	Short Circuit	Cadet	Limit
A (Driver onboard)	25mm	25mm	Minimum
	60mm	60mm	Maximum
B	180mm (150mm gearbox)	150mm	Maximum
C	60mm	60mm	Maximum
D	50mm	50mm	Minimum
	300mm	300mm	Maximum
E	250mm	250mm	Minimum
	300mm	300mm	Maximum
F	680mm (650mm gearbox)	500mm	Maximum
	1000mm	700mm	Minimum
G	External width of front track	1000mm	Maximum
	40mm	40mm	Maximum
H	40mm	40mm	Maximum
I	150mm	150mm	Maximum

Drawing number 7

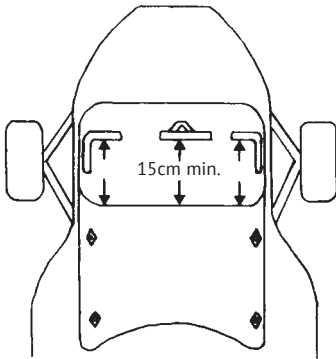

Lower end of bubbleshield showing minimum 15cm gap between shield and pedals. Also indicating the maximum 4 fixing points if shield attached to bodywork.

Diagram 6

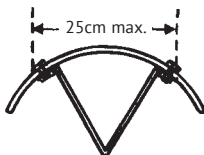
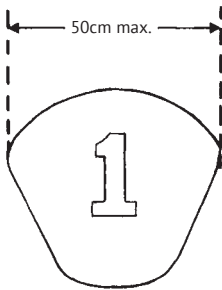

Bubbleshield showing overall width dimensions and the maximum width of supports.

Diagram 7

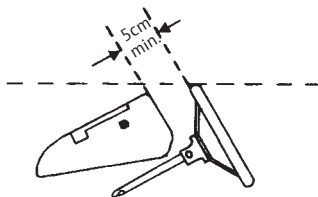

Bubbleshield profile showing horizontal line it must not cross and the minimum 5cm gap between the shield and steering wheel.

Diagram 8

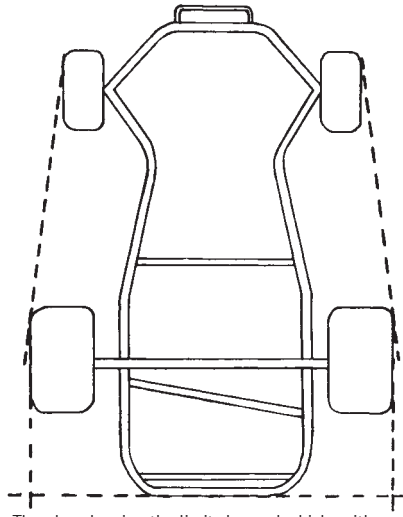

The plan showing the limits beyond which neither bodywork, wings or end plates may protrude. (Kart in dry tyre condition.)

Diagram 9



Floor tray. Showing legal and illegal. Illegal is defined as creating a skirt effect.

Diagram 10

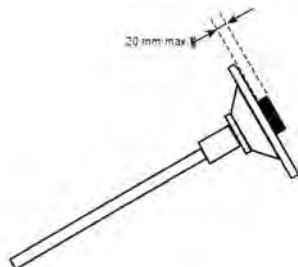

Steering wheel projection.

Diagram 8a

Drawing number 8

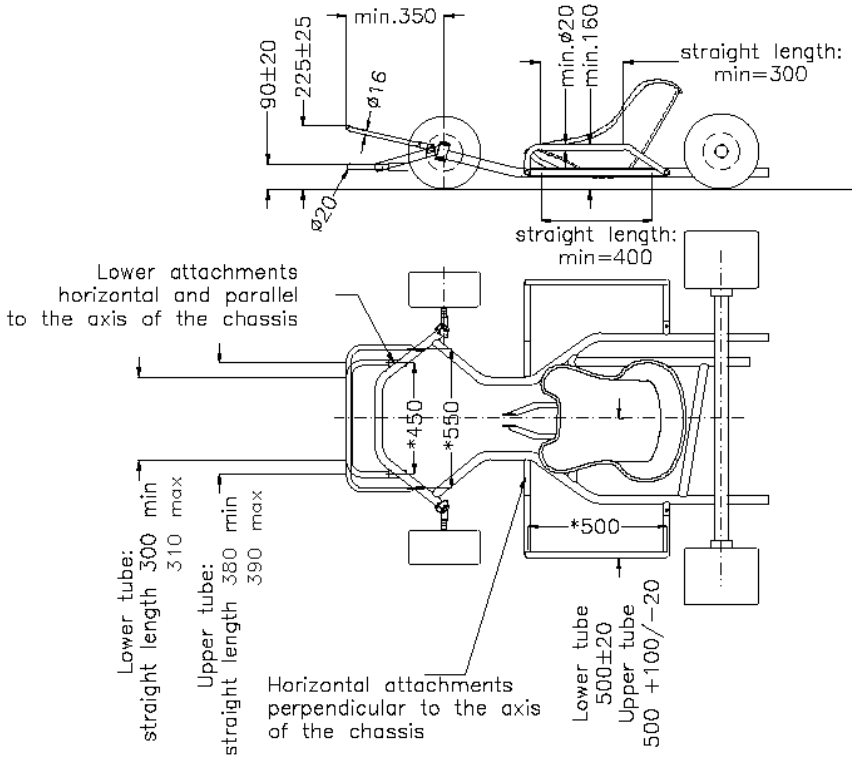

*Lower Tube $\phi 20\text{mm}$
with one constant radius.*

*Upper tube $\phi 16\text{mm}$
with one constant radius.*

** $\pm 5\text{mm}$, tube axes
dimensions
Dimensions in mm*

Drawing number 14

DRIVER AGES

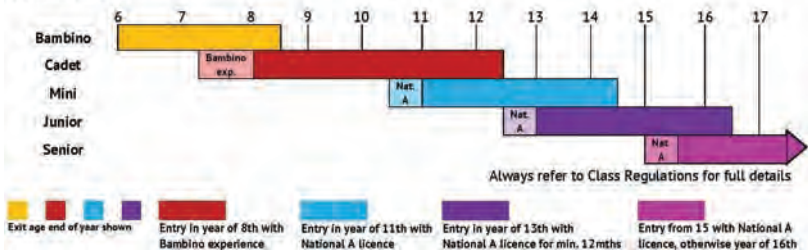

Drawing number 7.5.1

STARTING GRID

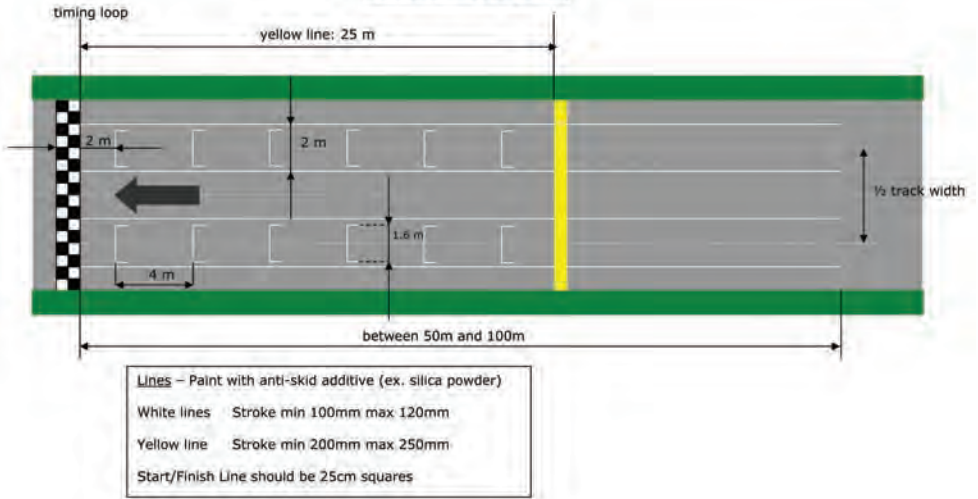

Drawing number 17.25

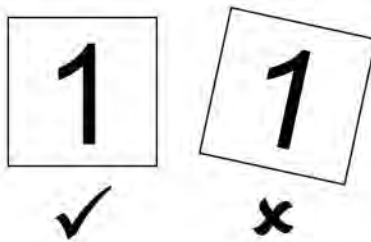

Drawing number 17.30

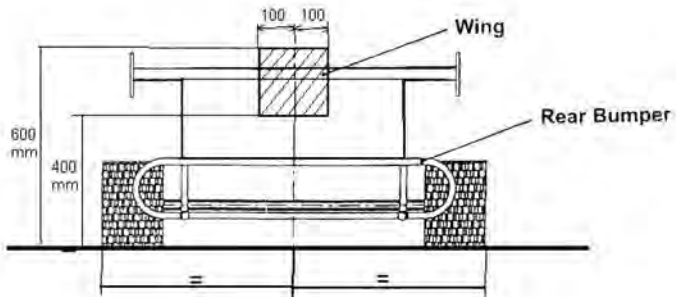

Drawing number 17.5

Correct position

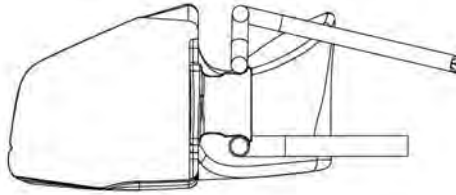

Unacceptable position – if any part of the front bumper tubes is in an area marked 'A'

